

CEDE



ALUMINIUM PROFILES , SOFT CLOSE DRAWER , HINGES SERIES , FURNITURE & DOOR HINGES , CONNECTINGS SERIES , BOARD SUPPORT SERIES , HANGING RAIL TUBE SERIES , STEEL DRAWER METAL-BOX , DRAWER BOX , SLIDING SYSTEM , GAS SPRING , LIFT

CEDE



HINGES SERIES	7.1
35MM	7.2
110 DEGREE ALUMINIUM HINGE	7.3
110 DEGREE CUP 35MM HINGE	7.4 - 7.6
105 DEGREE CUP 35MM HINGE	7.7
FURNITURE & DOOR HINGES	7.8
SOFT CLOSE DRAWER	7.9 - 7.16
STEEL DRAWER METAL-BOX	7.17 - 7.18
DRAWER BOX	7.19 - 7.20
DRAWER SLIDES	7.21
SLIDING SYSTEM	7.22 - 7.24
CONNECTINGS SPEADING DOWEL	7.25
CONNECTINGS FITTINGS SERIES	7.26 - 7.28
BOARD SUPPORT SERIES	7.29 - 7.30
CABINET FITTING SERIES	7.31
HANGING RAIL TUBE SERIES	7.32 - 7.35
GAS SPRING	7.36 - 7.37
LIFT	7.38 - 7.39
ALUMINIUM PROFILES	7.40 - 7.51

Hinge series

The feature of clamp-on style hinges is with the function of clip-on, inserting the hinge into the base (a-1 picture), then pressing the arm of the hinge with your fingertip slightly to hook the base (picture a-2). A click sound is clearly heard.

The arm of the hinge can be hooked safely into the base by 5 supports.

Basically the process of clip-on can be done through hooking the front part into the base, from top to bottom. The upper hinge is bearing all the load of the door.

On the contrary, the process of dismantling is done from bottom to top.

Pulling gently the spring pin (as it shows on c-2) to dismantle the hinge.

In the same way, the door can be removed from the front by taking off the arm from the base c-2.



A



B



C

The quantity of hinges

The quantity of hinges needed for matching each door depends on the following factors:

- 1- The width and the height of the door.
- 2- The material quality.

Therefore, the means of the assembling which is demonstrated on the right side is for your reference only. Thus, we suggest that you do a test before, if you are not clear. "L" volume shall be relatively large considering stability.

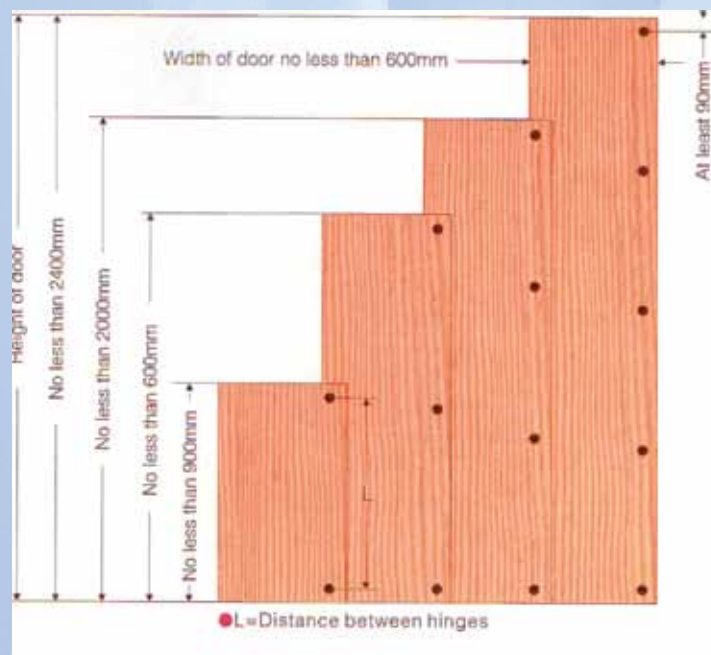

35mm Soft close hinge Clip-on:

Open angle 110° - Diameter of hinge cup 35mm – Cup depth 11.5mm – Drilling distances on the door (k):3-6mm – Range of door thickness: 15-25mm
 Door adjustment : Height=+2mm-2mm
 Side=+2mm-2mm
 Depth=+3mm-1mm

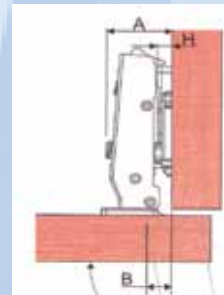
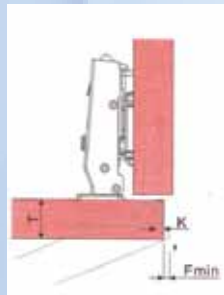
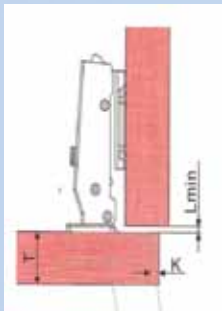
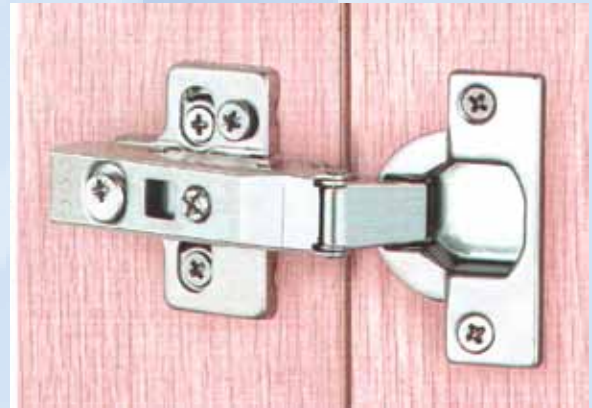
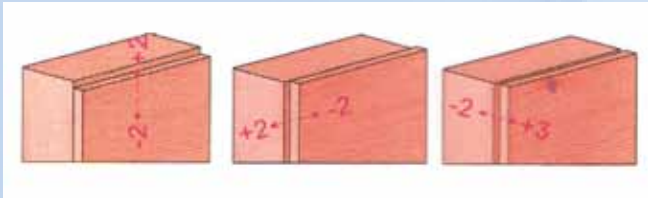

Minimum Gap

Lmm	K=J	4	5	6
15	U	2	3	3.5
16	D	3	C	3.7
17	D	3	C	3.8
18	D	3	C	4.0
19	D	3	0.3	4.2
20	D	3	0.4	4.3
21	D	3	0.5	4.5
22	D	3	0.7	4.7
23	D	3	0.9	4.9
24	D	0.1	1	5.0
25	U	0.2	1.2	5.2

L= Full cover & half cover hinge

Minimum Reveal

Lmm	K=3	4	5	6
15	0.7	0.7	0.7	0.7
16	1.0	1.0	0.9	0.9
17	1.2	1.2	1.1	1.1
18	1.4	1.4	1.3	1.3
19	1.6	1.6	1.5	1.5
20	1.8	1.7	1.6	1.6
21	2.0	1.9	1.8	1.8
22	2.2	2.1	2.0	2.0
23	2.4	2.3	2.2	2.2
24	2.6	2.5	2.4	2.4
25	2.8	2.7	2.6	2.6

For Full cover, call from 0.5mm to 1.0mm

Hinge Profiles - Door Profiles

	e	3
Full Overlay	ES-1	ESH
Half Overlay	ES-1	ES-1
Inset	ES-1H	ES-1H

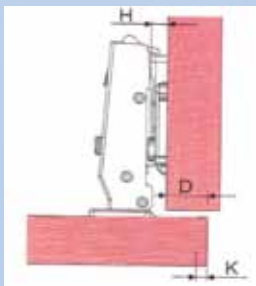

$H = 11 + K - D$
Crank 0

Overlay:D

D	H=0	2	4
K=3	14	12	10
4	15	13	11
5	16	14	12
6	17	15	13

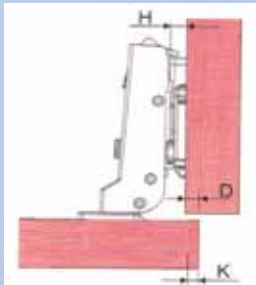
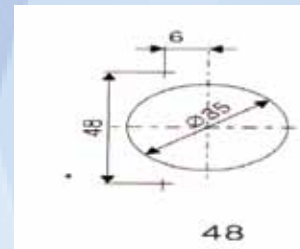

$H = 1.5 + K - D$
Crank 9.5

Overlay:D

D	H=0	2	4
K=3	4.5	2.5	0.5
4	5.5	3.5	1.5
5	6.5	4.5	2.5
6	7.5	5.5	3.5

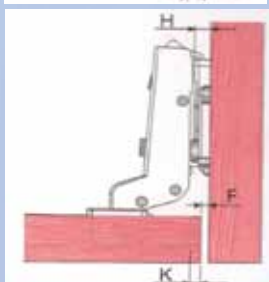

$H = -7 + K + F$
Crank 18

Reveal:F

D	H=0	2	4
K=3	4	6	8
4	3	5	7
5	2	4	6
6	1	3	5

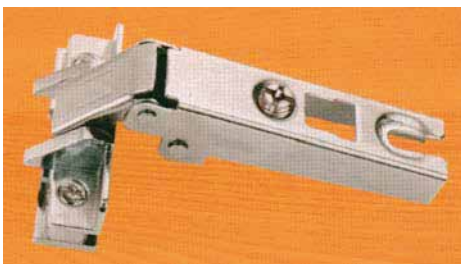
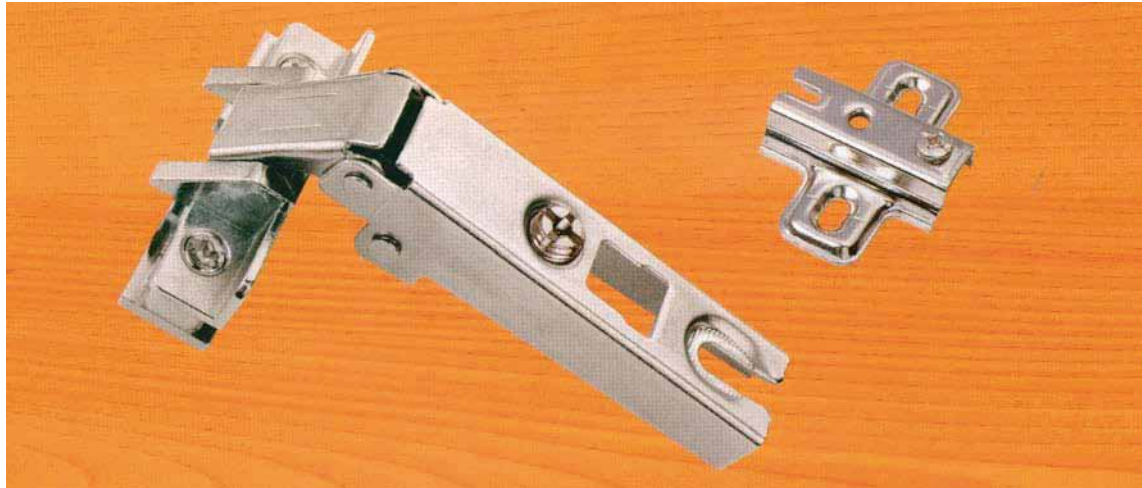

RCQC04MZ

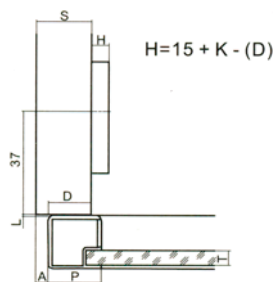

D \ H \ K	3	4	5	6
0	18	19	20	21
2	16	17	18	19
4	14	15	16	17



RCQC04MA

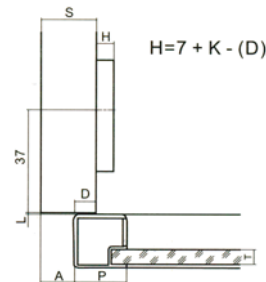

D \ H \ K	3	4	5	6
0	10	11	12	13
2	8	9	10	11
4	6	7	8	9



RCQC04MB

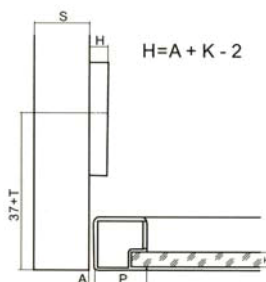

D \ H \ K	3	4	5	6
0	-1	-2	-3	-4
2	1	0	-1	-2
4	3	2	1	0

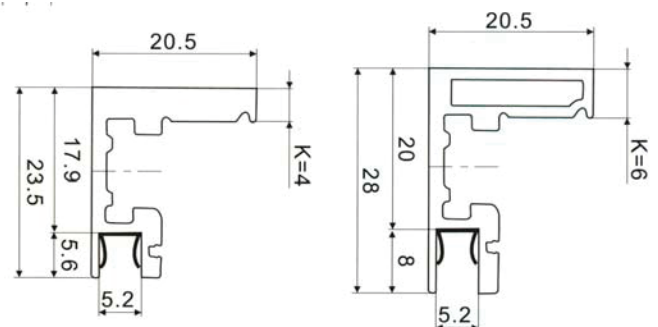

Formulas below can be used according to different types of arm of hinges, and need the figures of both drilling holes "K" on the door and the height of the assembling panel "H" when solving problem

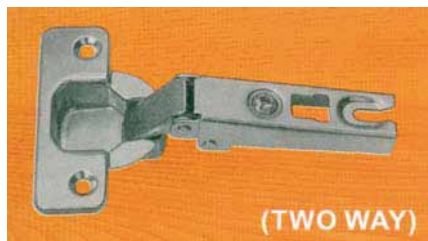

(TWO WAY)

RCQC06Z

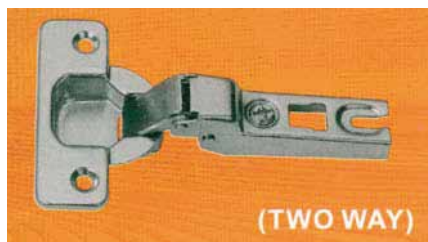
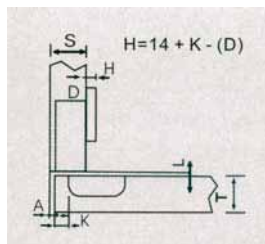

(TWO WAY)

RCQC06A

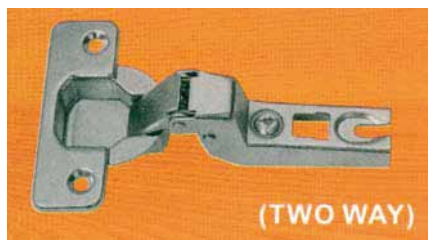
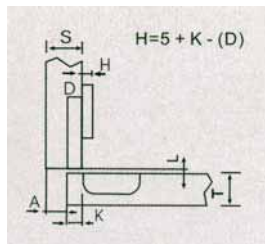

(TWO WAY)

RCQC06B

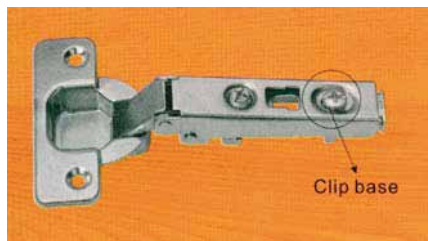
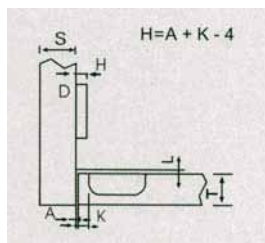

Clip base

RCQC06ZO

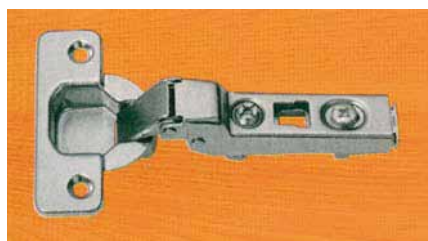
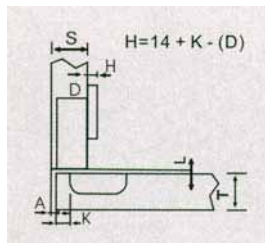

RCQC06AO

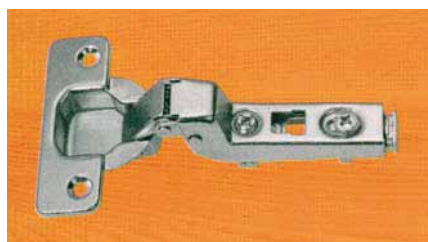
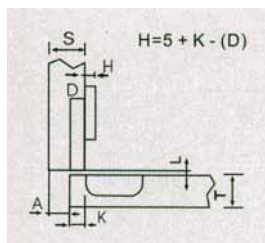

RCQC06BO

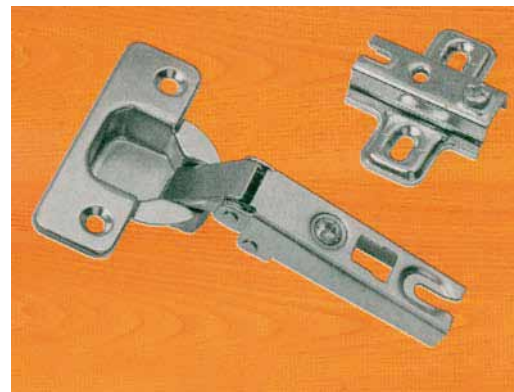
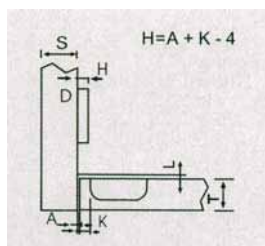

H=height of the fitting panel
 K=the distance between the panel outline and hinge cup
 D=the panel on the cupboard
 A=half-side of the door-frame
 L=inner-line of the panel
 T=the maximum height of the door
 S=the thickness of the side if the cupboard

Technical drawings showing three hinge variants with different C values (0, 8, 15) and their corresponding dimensions. Includes hole patterns for mounting plates and a table of part numbers.

■ steel two holes mounting plate			
Height			
H=0	H0ALA	H0BLA	H0CLA
H=2	H2ALA	H2BLA	H2CLA
H=4	H4ALA	H4BLA	H4CLA

■ steel four holes mounting plate			
Height			
H=0	H0ALA2		
H=2	H2ALA2		
H=4	H4ALA2		



(ONE WAY)

RCQC06MZ

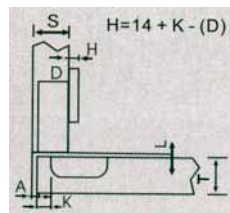

(ONE WAY)

RCQC06MA

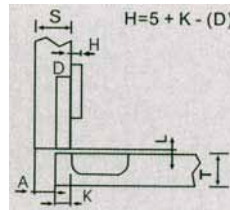

(ONE WAY)

RCQC06MB

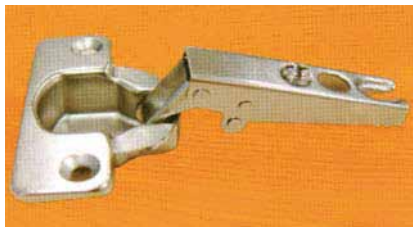
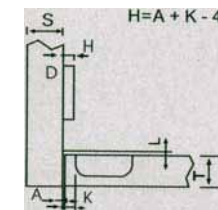

RCQCJ216Z(35mm cup)

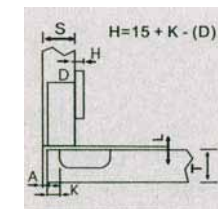

RCQCJ216A(35mm cup)

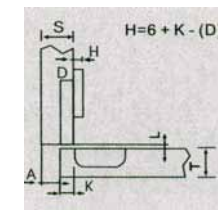

RCQCJ216B(35mm cup)

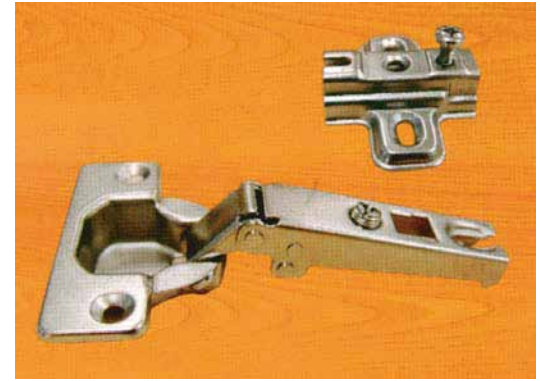
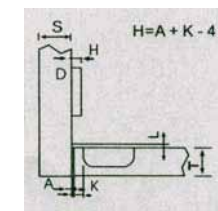

H=height of the fitting panel
 K=the distance between the panel outline and hinge cup
 D=the panel on the cupboard
 A=half-side of the door-frame
 L=inner-line of the panel
 T=the maximum height of the door
 S=the thickness of the side if the cupboard

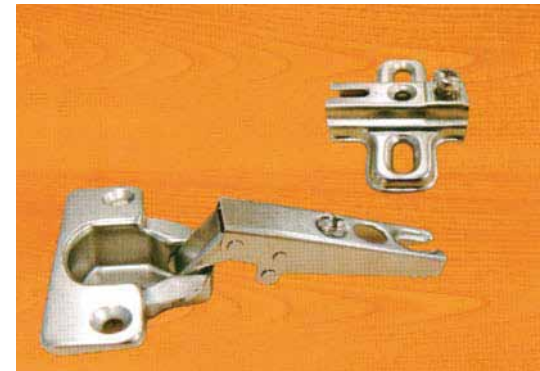
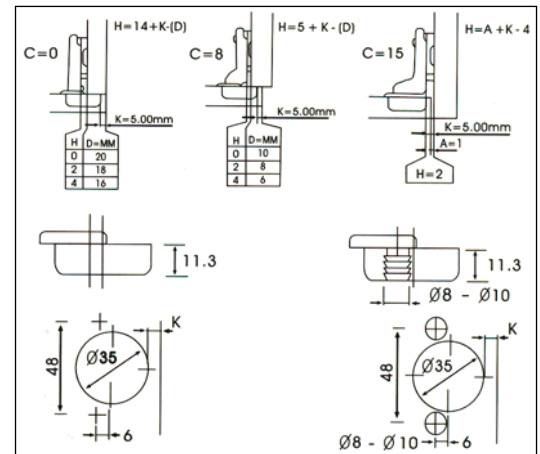

■ steel two holes mounting plate

Height			
H=0	H0ALA	H0BLA	H0CLA
H=2	H2ALA	H2BLA	H2CLA
H=4	H4ALA	H4BLA	H4CLA

■ steel four holes mounting plate

Height			
H=0	H0ALA2		
H=2	H2ALA2		
H=4	H4ALA2		

110° Cup 35mm Hinge



RCQCJ218Z

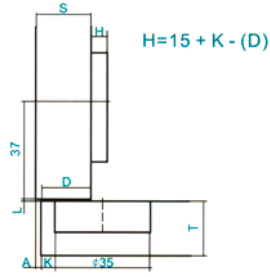

RCQCJ218A

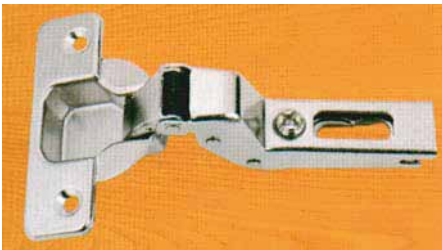
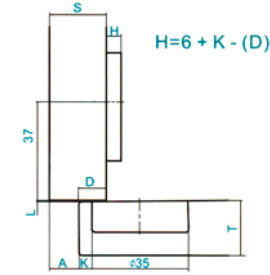

RCQCJ218B

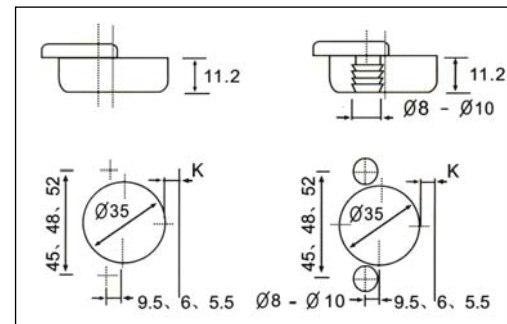
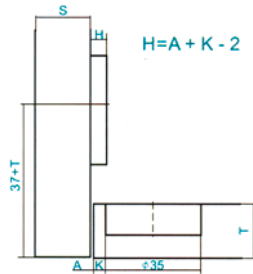

110° Cup 35mm Hinge

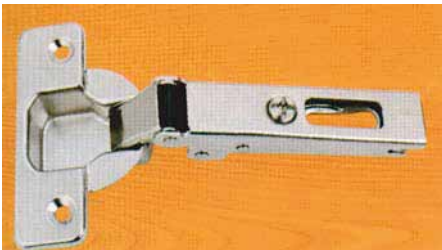

RCQCJ218ZO

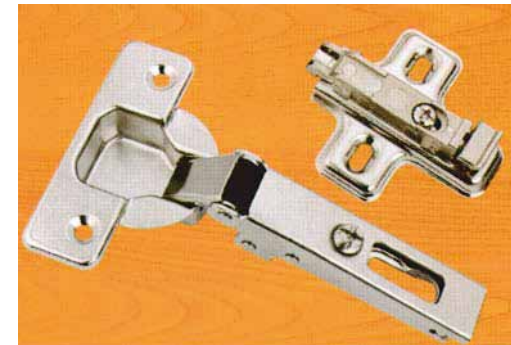
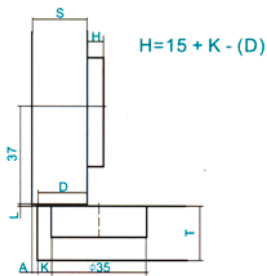

RCQCJ218AO

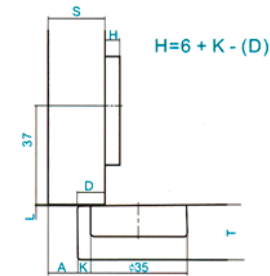

RCQCJ218BO

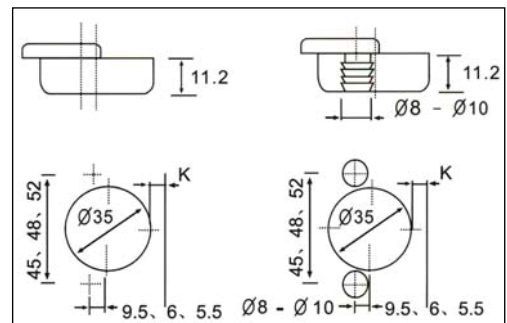
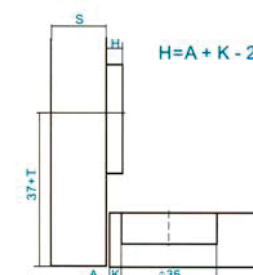

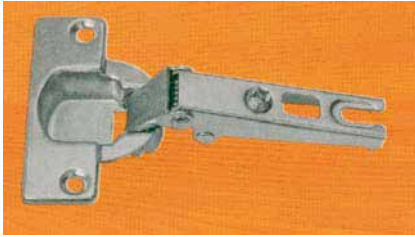

RCQC08Z

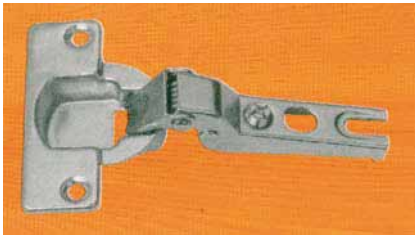
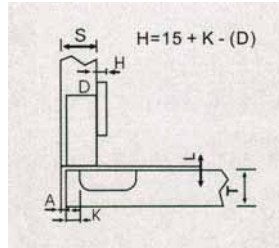

RCQC08A

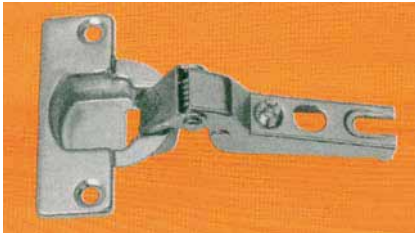
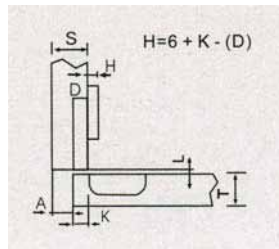

RCQC08B

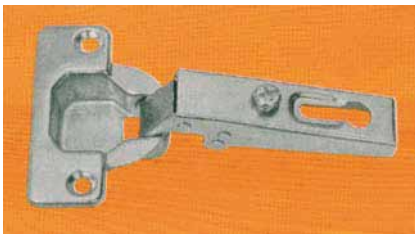
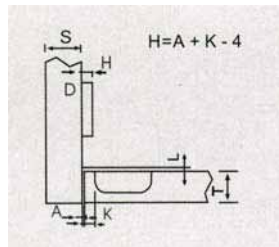

RCQC010Z

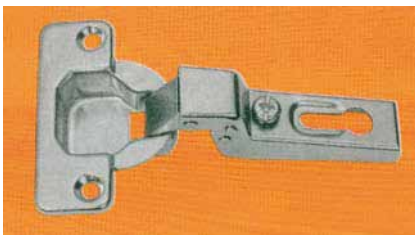
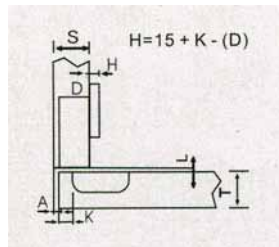

RCQC010A

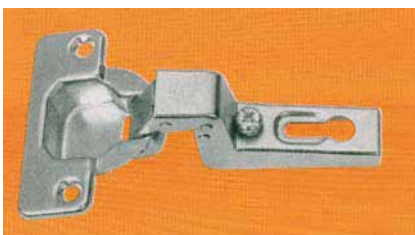
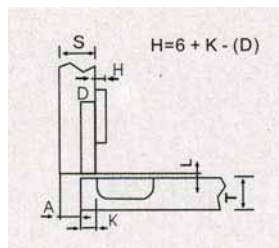

RCQC010B

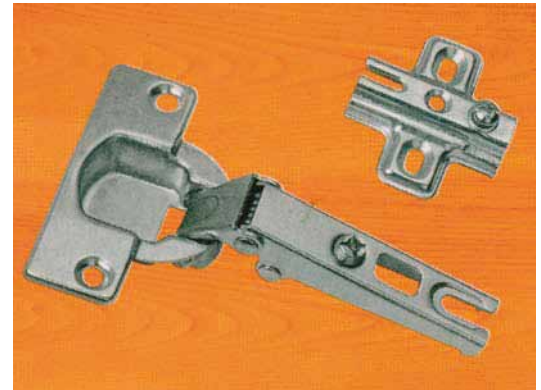
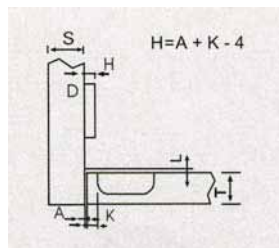

H=height of the fitting panel
 K=the distance between the panel outline and hinge cup
 D=the panel on the cupboard
 A=half-side of the door-frame
 L=inner-line of the panel
 T=the maximum height of the door
 S=the thickness of the side if the cupboard

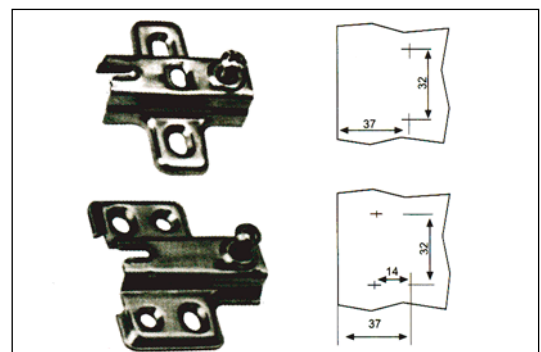
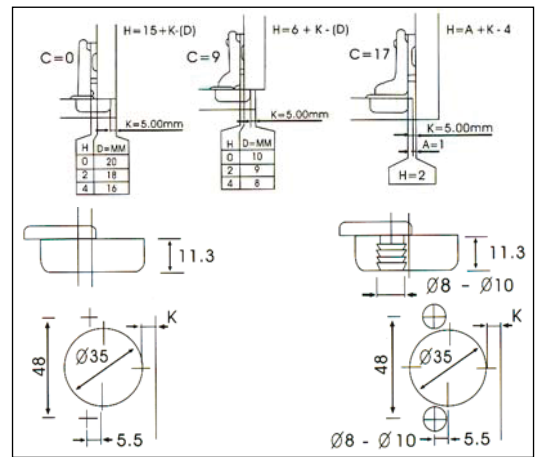

■ steel two holes mounting plate

Height			
H=0	H0ALA	H0BLA	H0CLA
H=2	H2ALA	H2BLA	H2CLA
H=4	H4ALA	H4BLA	H4CLA

■ steel four holes mounting plate

Height			
H=0	H0ALA2		
H=2	H2ALA2		
H=4	H4ALA2		

Head Hydraulic Buffering Hinge

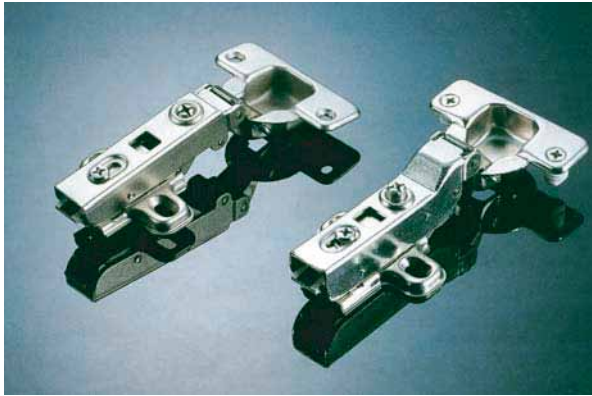

- * Suitable for wood cabinet
- * Max. opening angle is 105°
- * Optional with 3 installation methods
- * Cabinet wood door thickness is 14mm to 24mm
- * Passed the quality test of 50,000 cycles

Means of installation

There are mainly three types of installation

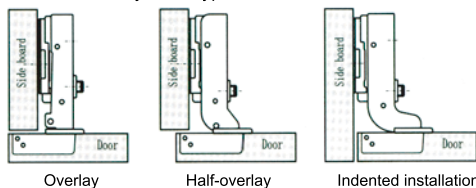

Overlay
The door overlaps the side board of cabinet, a gap is left between the door & the side board to allow safety opening of the door.

Half-overlay
Under such circumstances, 2 doors share the same sideboard & a minimal for smooth opening of both of the doors simultaneously. The overlay span of each door decreases. Thus a spacer plate is added for a half-overlay installation.

Indented installation
Under such circumstances, the door indents inside the sideboard. A gap shall also be reserved for safe opening of the door. Thus, a spacer plate is added for indent installation.

C Distance

C distance refers to the distance from the door edge to the hinge edge. The bigger C distance is, the smaller the minimal gap will be (but the minimal gap can never exceed C distance which ranges from 4 to 6cm)

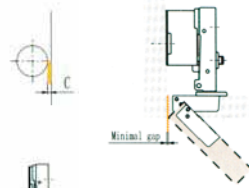

The minimal gap

The minimal gap refers to the distance from the door edge to the hinge edge. The bigger C distance is, the smaller the minimal gap will be (but the minimal gap will be can never exceed C distance which ranges from 4 to 6cm)

The overlay span of doors

The overlay span of doors refers to the span the door overlaying the sideboard

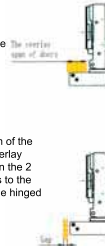

Gap

Gap refers to the distance between the side rim of the door on the hinged side & the doorframe (in overlay installation); Gap refers to the distance between the 2 doors (in half-overlay installation) & Gap refers to the distance between the side rim of the door on the hinged side & the side board (in indented installation)

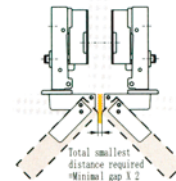

The minimal gap for half-overlay doors

When 2 doors share the same sideboard, the total smallest distance required shall be equal to 2 times that of the minimal gap so that the 2 doors can open smoothly at the same time.

The number of hinges needed for each door

There are many factors which may affect the number of hinges needed for each door. The width & the height of the door, the material of the door & the weight of the door, etc. Thus, the following statistics are for reference only. Laboratory tests may be necessary under individual cases. Out of safety consideration, the distance between 2 hinges shall be as large as possible.

X= the distance between two hinges
19mm flakeboard, proportion 750Kg/cubic meter)

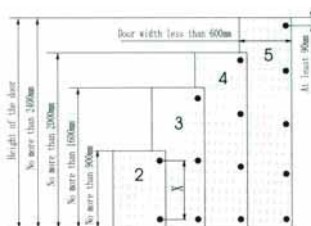

Installing the hinge

Installation instructions:

During the installation of overlay or half-overlay doors, the X measure in the figure is 38mm; during the indent installation, the X measure is 38 plus door thickness.

- A - Height-adjustment screws
- B - Depth-adjustment screws
- C - screws to adjust the gap from the door to the doorframe
- D - Fastening screws

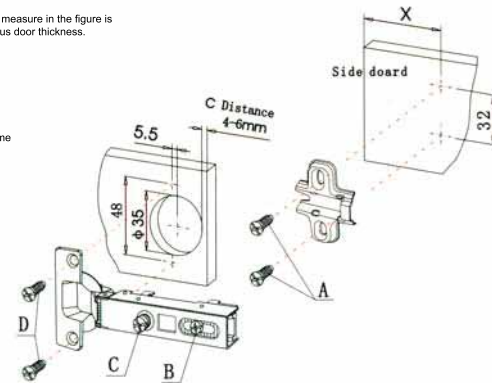

Door adjustment

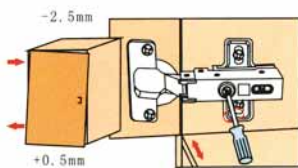

Adjustment of the gap from the door to the doorframe (see figure 1)

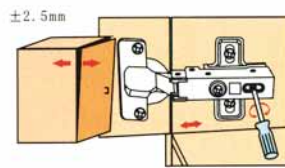

Depth adjustment (see figure 2)

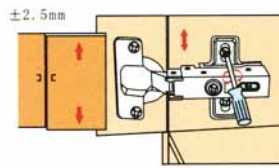

Height adjustment (see figure 3)

Turn screws clockwise
Door-doorframe gap decreases (-)
Turn screws anti-clockwise
Door-doorframe gap increases (+)

Concealed, Full extension, synchronized slides. Light opening & closing, smooth sliding. Quick installation and easy dismantling. Integrated 3D front panel adjustment. Dynamic loading capacity 35/50kg.

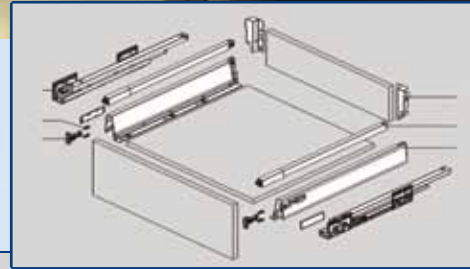

Nominal Length NL	Soft close drawer code
270mm	HDS149-270
300mm	HDS149-300
350mm	HDS149-350
400mm	HDS149-400
450mm	HDS149-450
500mm	HDS149-500
550mm	HDS149-550

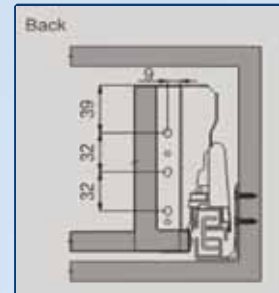
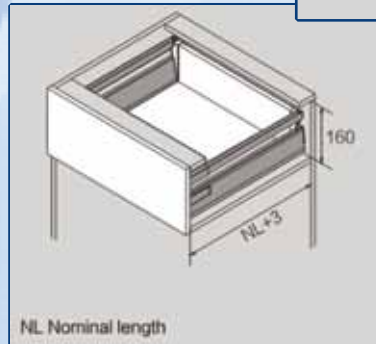

DRAWER INSTALLATION TECHNICS

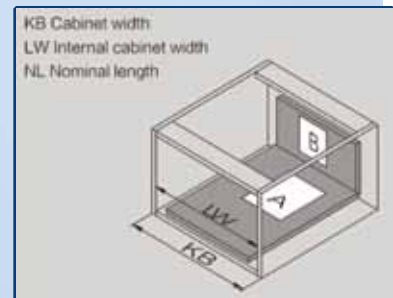
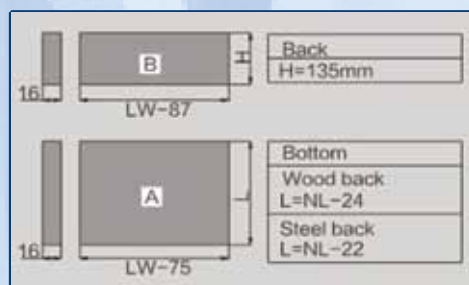
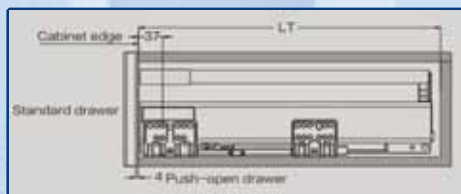
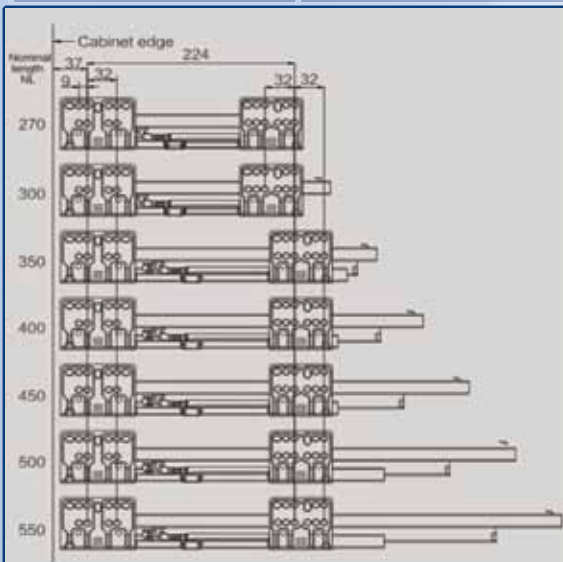
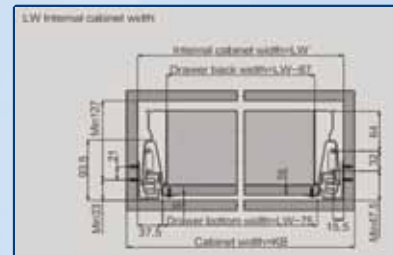
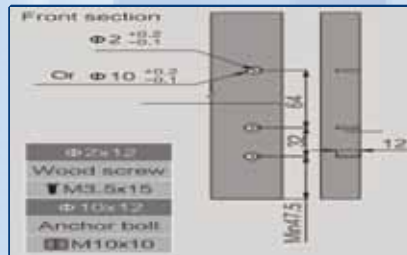

Concealed, Full extension, synchronized slides. Light opening & closing, smooth sliding. Quick installation and easy dismantling. Integrated 3D front panel adjustment. Dynamic loading capacity 35/50kg.

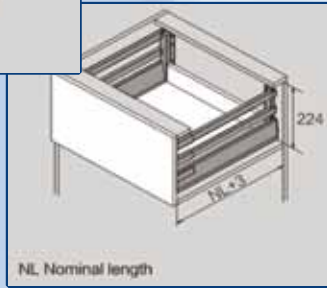
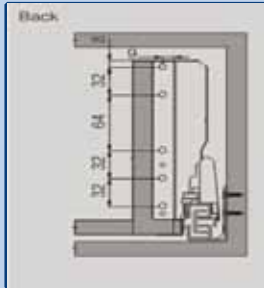
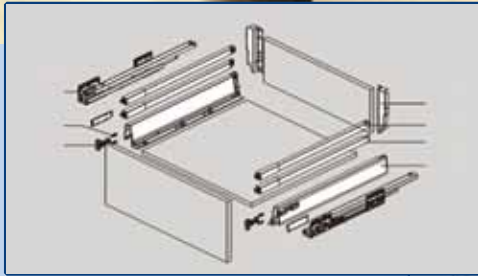

DRAWER INSTALLATION TECHNIKS

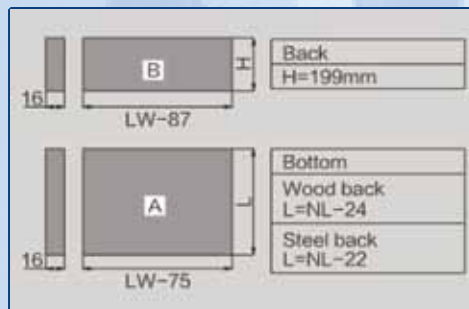
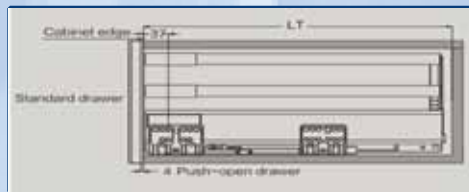
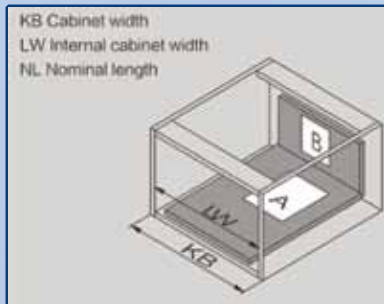
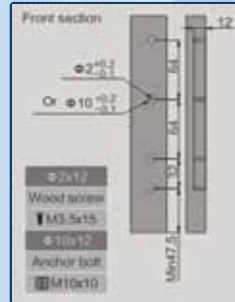
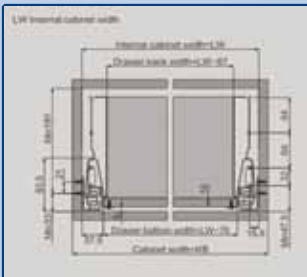

Nominal Length NL	Soft close drawer code
270mm	HDS150-270
300mm	HDS150-300
350mm	HDS150-350
400mm	HDS150-400
450mm	HDS150-450
500mm	HDS150-500
550mm	HDS150-550

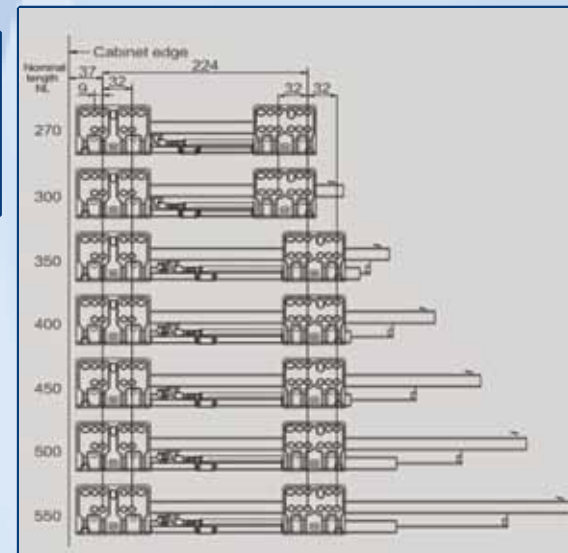

Concealed, Full extension, synchronized slides. Light opening & closing, smooth sliding. Quick installation and easy dismantling. Integrated 3D front panel adjustment. Dynamic loading capacity 35/50kg.

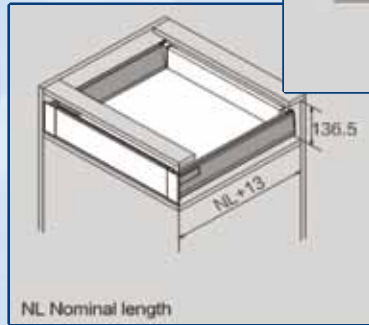
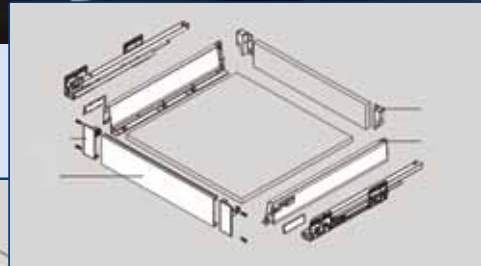

Nominal Length NL	Soft close drawer code
270mm	HDS147-270
300mm	HDS147-300
350mm	HDS147-350
400mm	HDS147-400
450mm	HDS147-450
500mm	HDS147-500
550mm	HDS147-550

DRAWER INSTALLATION TECHNICS

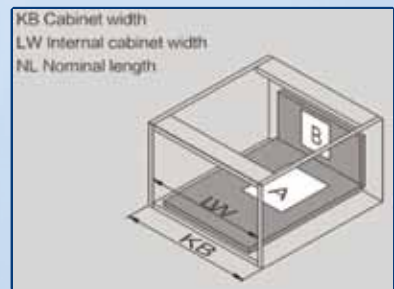
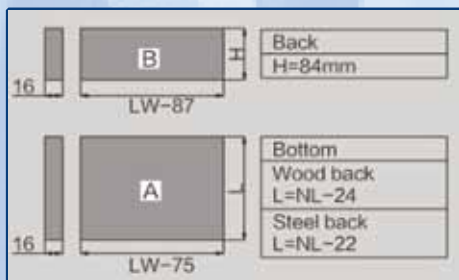
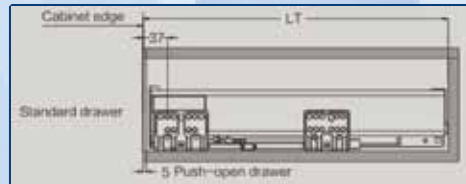
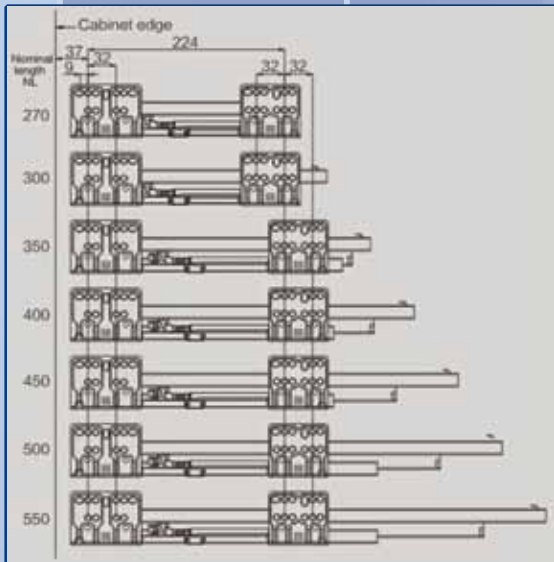
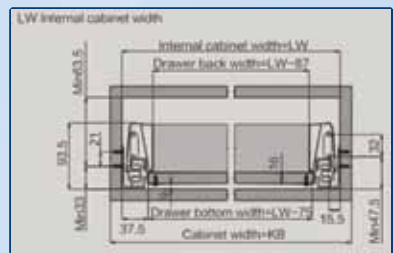
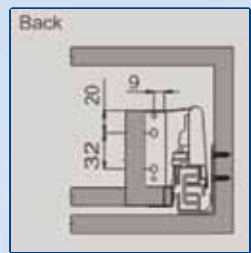
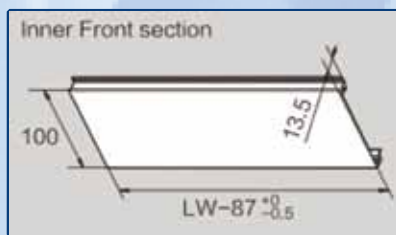



Concealed, Full extension, synchronized slides. Light opening & closing, smooth sliding. Quick installation and easy dismantling. Integrated 3D front panel adjustment. Dynamic loading capacity 35/50kg.

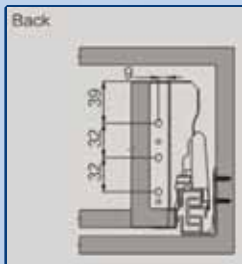
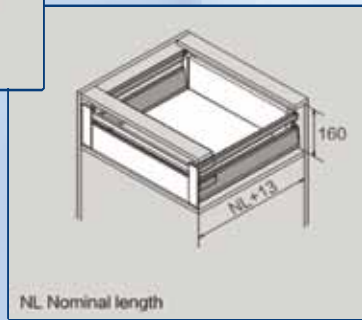
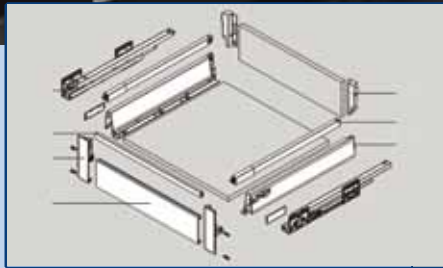

DRAWER INSTALLATION TECHNICS

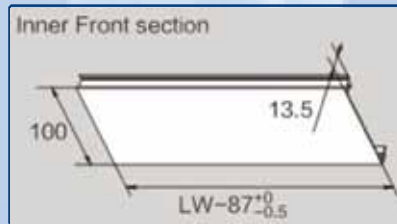
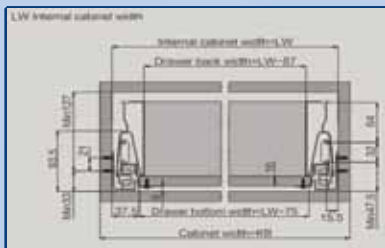

Nominal Length NL	Soft close drawer code
270mm	HDS146-270
300mm	HDS146-300
350mm	HDS146-350
400mm	HDS146-400
450mm	HDS146-450
500mm	HDS146-500
550mm	HDS146-550

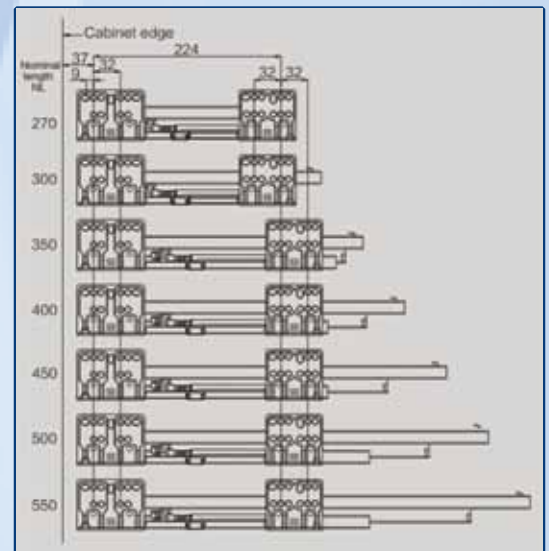
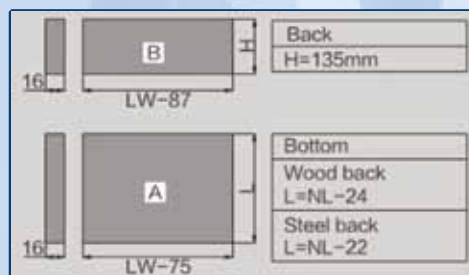
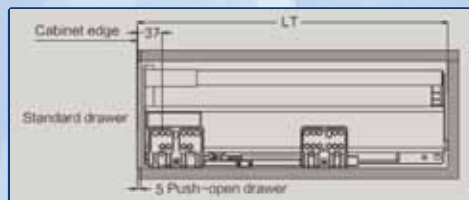
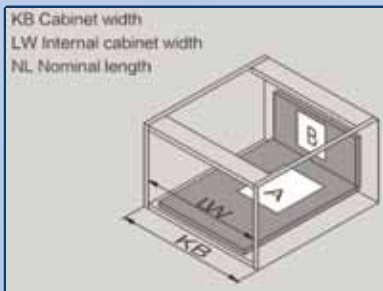

Concealed, Full extension, synchronized slides. Light opening & closing, smooth sliding. Quick installation and easy dismantling. Integrated 3D front panel adjustment. Dynamic loading capacity 35/50kg.

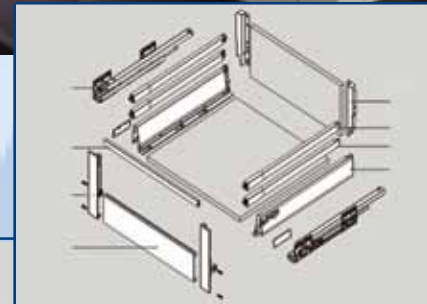

Nominal Length NL	Soft close drawer code
270mm	HDS151-270
300mm	HDS151-300
350mm	HDS151-350
400mm	HDS151-400
450mm	HDS151-450
500mm	HDS151-500
550mm	HDS151-550

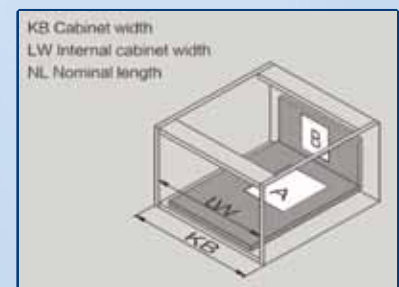
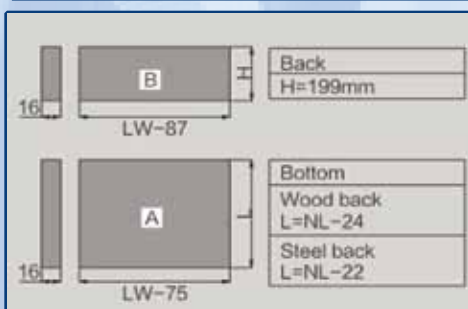
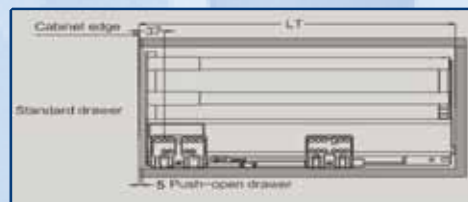
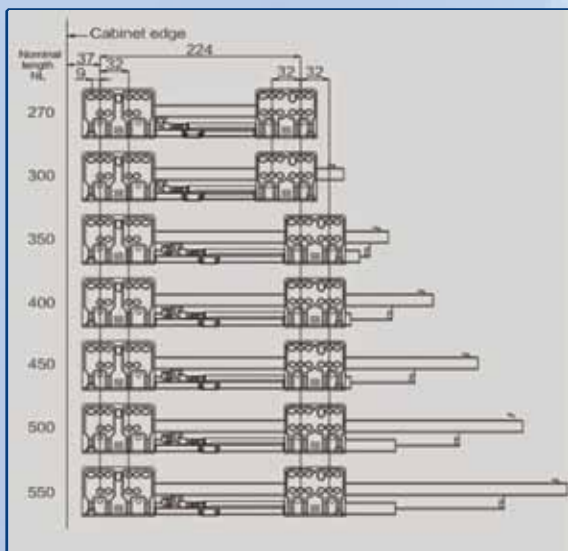
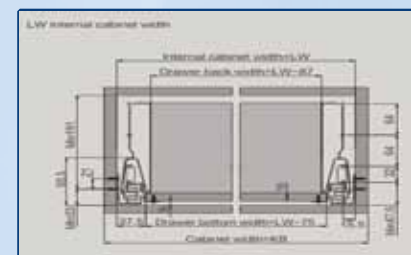
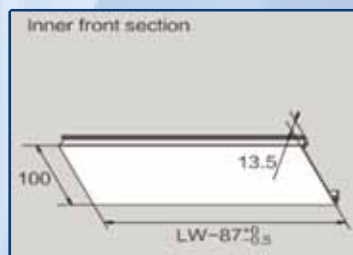
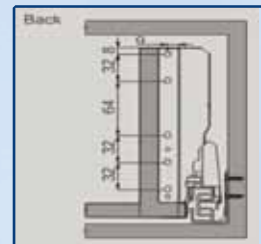
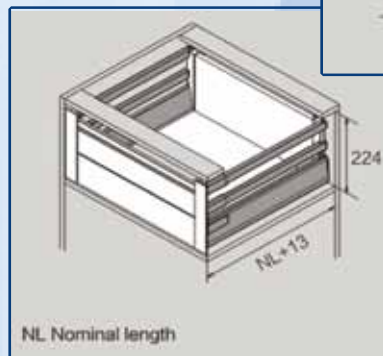



Concealed, Full extension, synchronized slides. Light opening & closing, smooth sliding. Quick installation and easy dismantling. Integrated 3D front panel adjustment. Dynamic loading capacity 50/60kg.

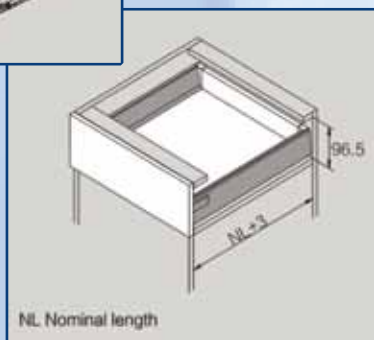
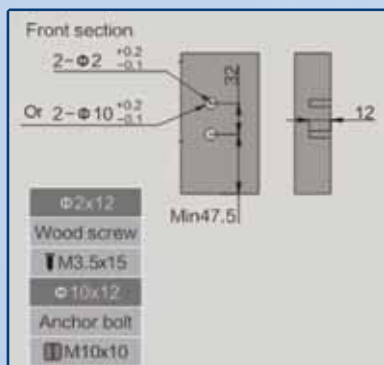
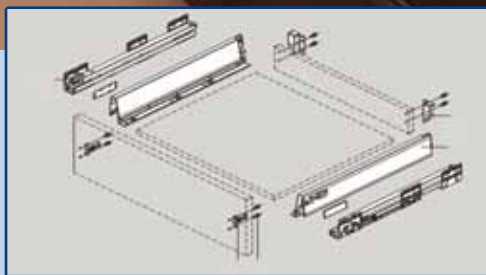

DRAWER INSTALLATION TECHNICS

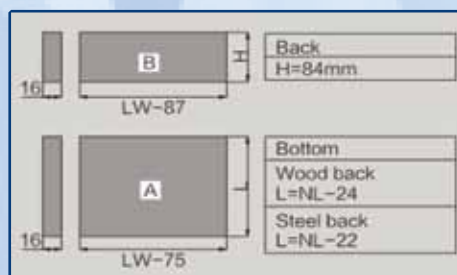
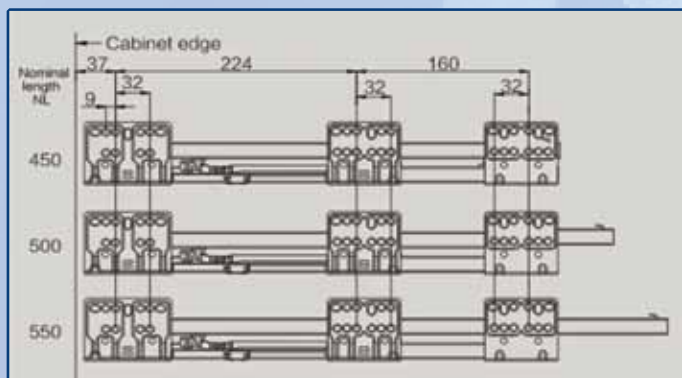
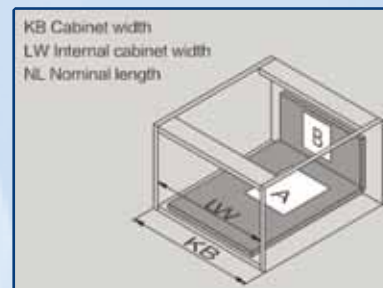
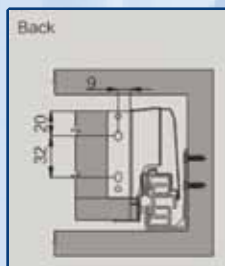
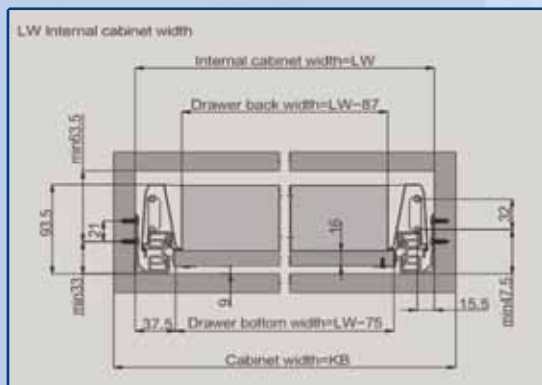

Nominal Length NL	Soft close drawer code
270mm	HDS148-270
300mm	HDS148-300
350mm	HDS148-350
400mm	HDS148-400
450mm	HDS148-450
500mm	HDS148-500
550mm	HDS148-550



RCCZ24

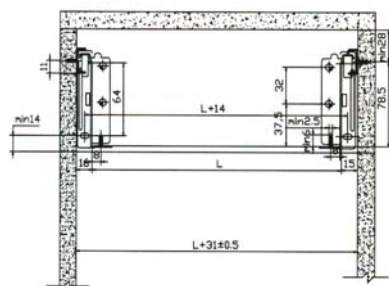

Drawer set, height 86mm
contains:
1 set drawer profiles, powder-coated steel
1 set roller runners, powder-coated steel

*8 nominal drawer lengths:
250/270/300/350/450/500/550mm

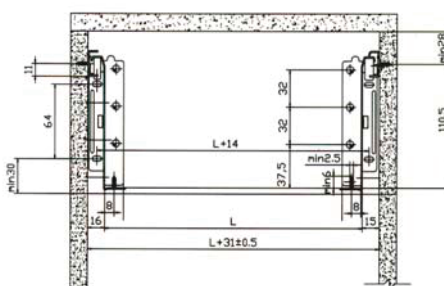

Drawer set, height 118mm
contains:
1 set drawer profiles, powder-coated steel
1 set roller runners, powder-coated steel

*8 nominal drawer lengths:
250/270/300/350/450/500/550mm

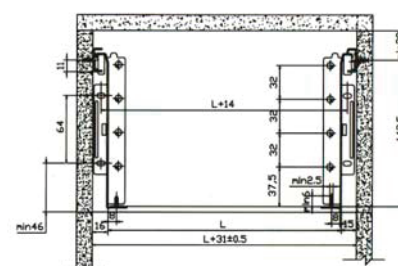

Drawer set, height 150mm
contains:
1 set drawer profiles, powder-coated steel
1 set roller runners, powder-coated steel

*8 nominal drawer lengths:
250/270/300/350/450/500/550mm

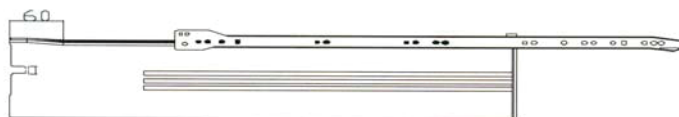

*Color option:
White, Black, Brown, Grey, Silver

Height Size	86 mm	118 mm	150 mm
250 mm	250 mm	250 mm	250 mm
270 mm	270 mm	270 mm	270 mm
300 mm	300 mm	300 mm	300 mm
350 mm	350 mm	350 mm	350 mm
400 mm	400 mm	400 mm	400 mm
450 mm	450 mm	450 mm	450 mm
500 mm	500 mm	500 mm	500 mm
550 mm	550 mm	550 mm	550 mm

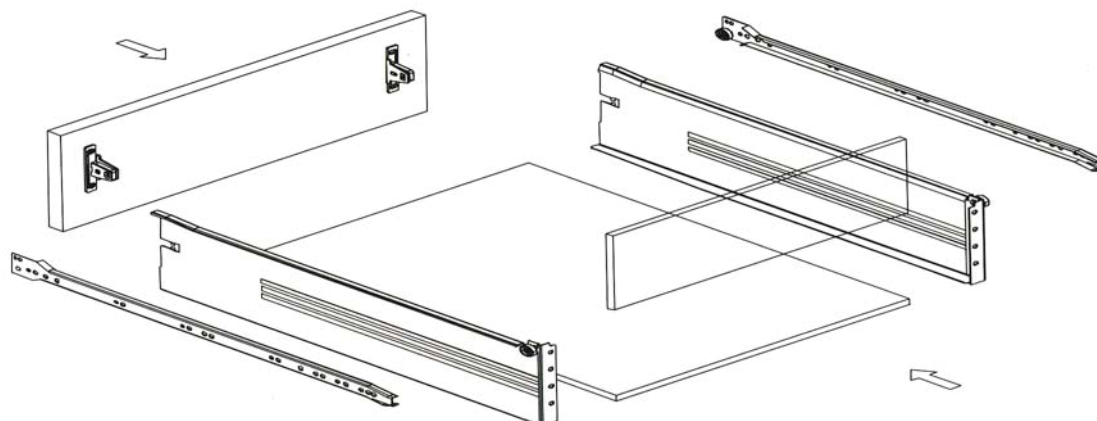

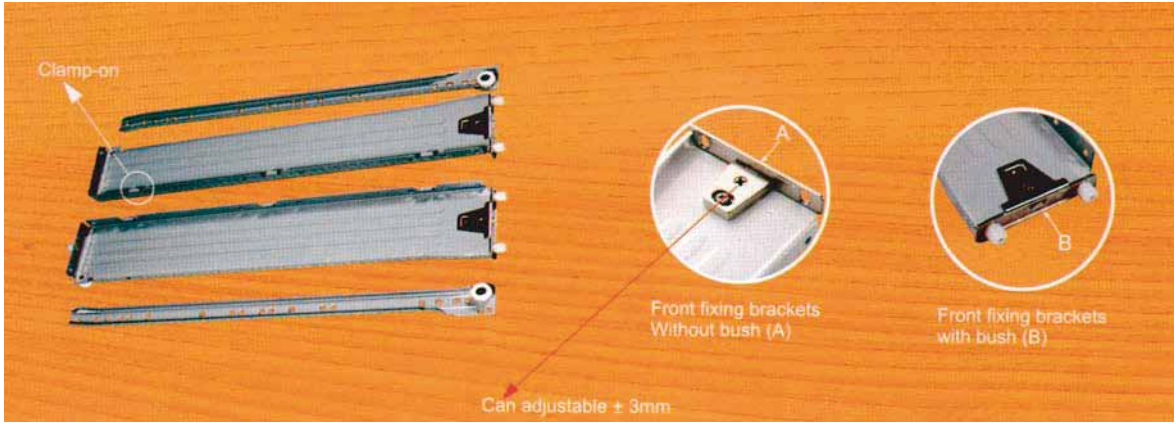

RCCZ26

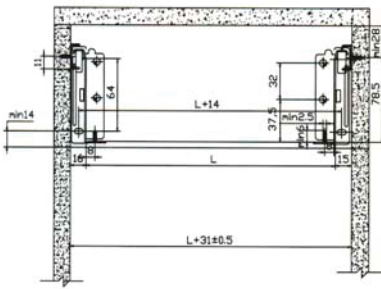

Drawer set, height 86mm
contains:
1 set drawer profiles, powder-coated steel
1 set roller runners, powder-coated steel

*8 nominal drawer lengths:
250/270/300/350/450/500/550mm

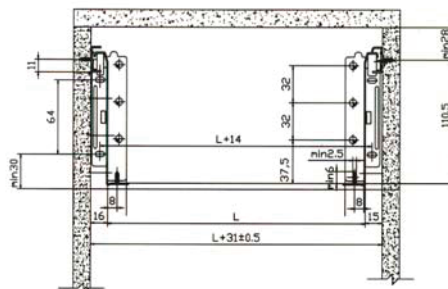

Drawer set, height 118mm
contains:
1 set drawer profiles, powder-coated steel
1 set roller runners, powder-coated steel

*8 nominal drawer lengths:
250/270/300/350/450/500/550mm

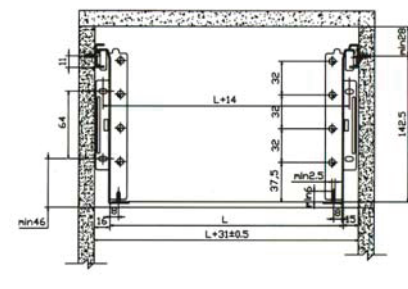

Drawer set, height 150mm
contains:
1 set drawer profiles, powder-coated steel
1 set roller runners, powder-coated steel

*8 nominal drawer lengths:
250/270/300/350/450/500/550mm

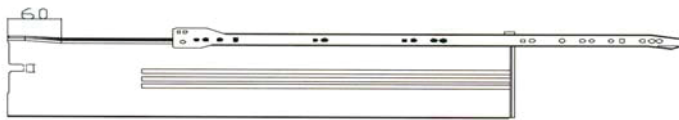

*Color option:
White, Black, Brown, Grey, Silver

Height Size	86 mm	118 mm	150 mm
250 mm	250 mm	250 mm	250 mm
270 mm	270 mm	270 mm	270 mm
300 mm	300 mm	300 mm	300 mm
350 mm	350 mm	350 mm	350 mm
400 mm	400 mm	400 mm	400 mm
450 mm	450 mm	450 mm	450 mm
500 mm	500 mm	500 mm	500 mm
550 mm	550 mm	550 mm	550 mm

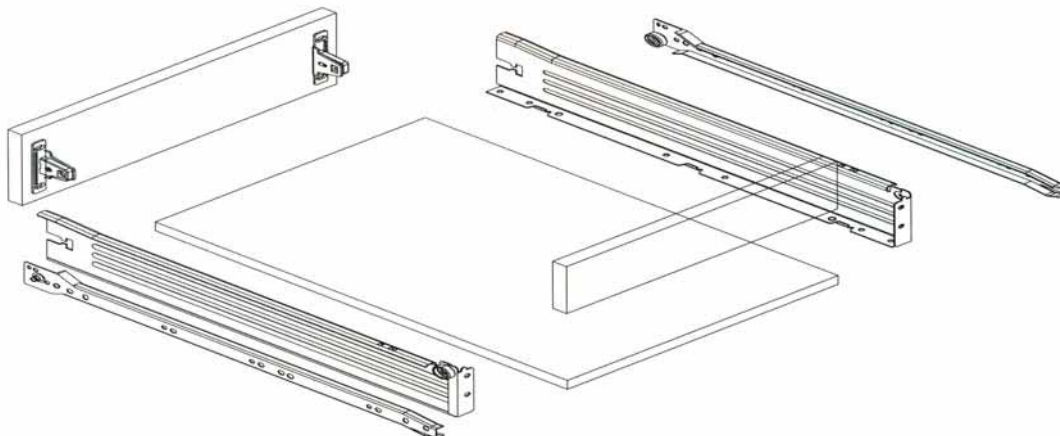



Features

- * 5 size drawer available
- * Color silver
- * Custom made drawer width
- * Install without other help and front plate can be adjusted easily
- * Easy to load the drawer
- * TOT B6 full extension slide installed

Steel made & all size drawer

Material for a imple drawer: 1- basic drawer structure+ rear cover, 16mm thick 2- Front joints+ bottom, 16mm thick

Code	Length	Coated steel code	Stainless steel code
RCO4120	260	501	511
RCO6100	350	502	512
RCO840	420	503	513
RCO8140	470	504	514
RCO1040	520	505	515

Basic box structure content
 *1 set of metal box, coated finish
 steel & stainless steel available
 *2 plastic side cover
 *1 rear plate joint

Item description	Item NO
Front joint	701

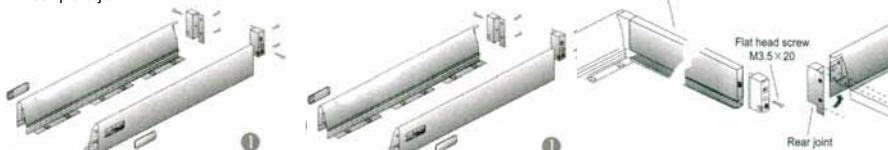

Technical Data

Drawer

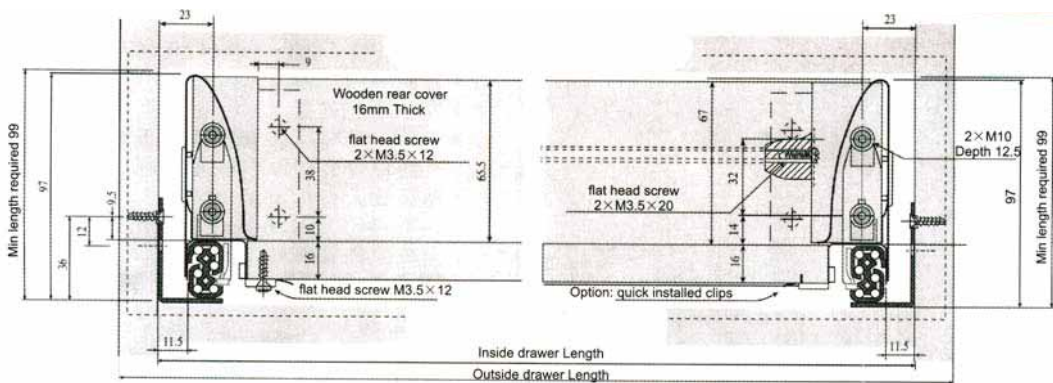

Front plate

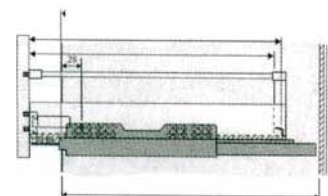

Code	Drawer Length	Coated steel code	Stainless steel code
RCQSNSA124120	260	501	511
RCQSNSA126100	350	502	512
RCQSNSA12840	420	503	513
RCQSNSA128140	470	504	514
RCQSNSA121040	520	505	515

Wooden rear cover installation

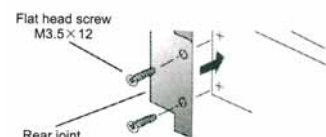

Drawer

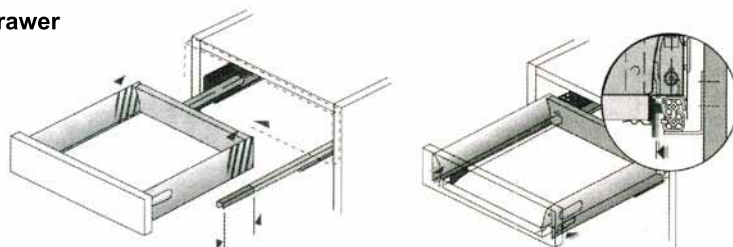

Measurement

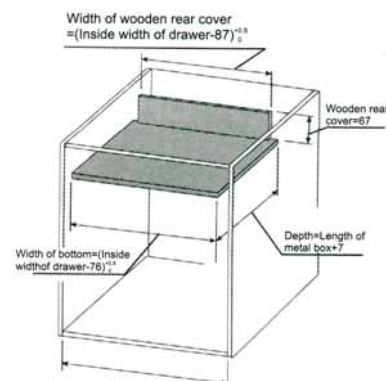

Front plate

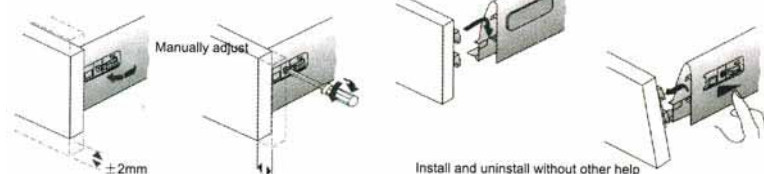

Concealed slide for wooden drawers with integrated AIRMATIC

Metro wood. Code 141026

- Integrated **AIRMATIC**
- Full extension with cylindrical roller carriage
- Quick & easy installation & removal of the drawer
- Front panel height adjustment feature requires no tools
- Simple assembly
- Smooth & quiet glide
- Dual-sided self closing softmatic

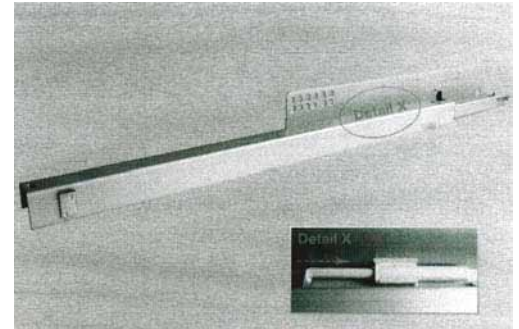

Cabinet members
Hole pattern for
full extension GS141026

Slide length	L1	L2
250 - 270	160	96
300 - 400	224	128
450	288	128
470 - 500	288	224
600	288	288

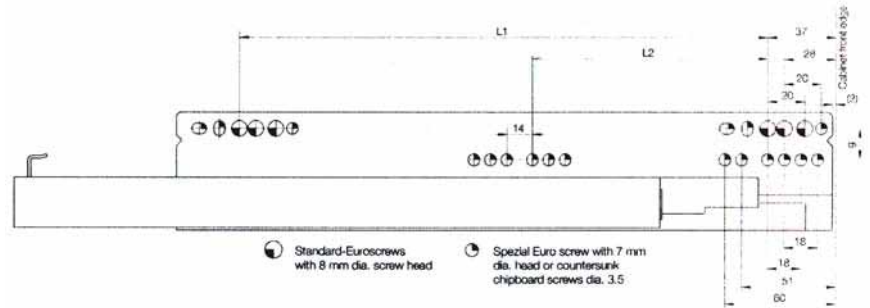

Assembly of snap-in device



Installation measurements

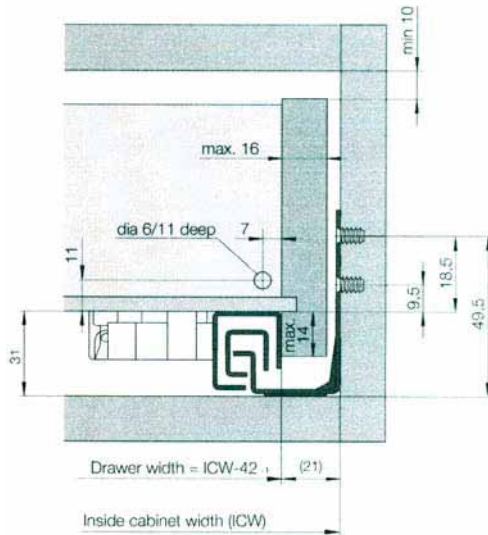

Type GS141026	Standard length	Code	Code
	250	1041612101610	104161210010
	270	1041612121610	104161212010
	300	1041612141610	104161214010
	350	1041612161610	104161216010
	400	1041612181610	104161218010
	450	104161401610	10416140010
	470	104161421610	10416142010
	500	104161441610	10416144010
	550	104161461610	10416146010
	600	104161481610	10416148010

Snap-in devices for Metro Wood, Packed as set (le + ri)

5 sets 20 sets
GS10610100006 GS10610100010

Snap-in devices for Metro Wood
Packing unit, 20 pieces (le + ri)

Left Right
GS106680010 GS1066618010

Sliding System



Kitchen systems
Concealed slide

Drawer slide roller & epoxic paint finish.
Self-closing system for an automatic closure due to the inclination of both parts of the slide.

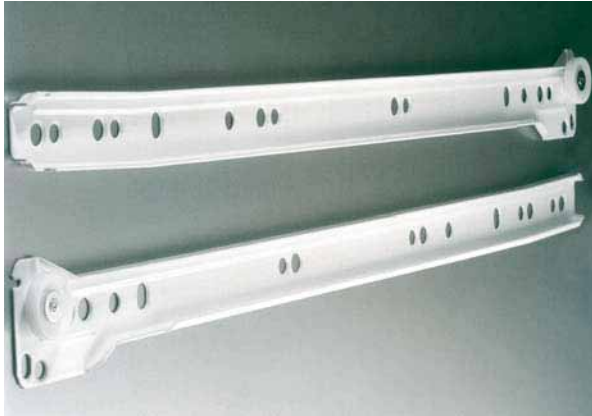

Uses	Office & kitchen furniture
Capacity	25 Kg
Life utility	10 years - 40.000 cycles
Components	1 inner right slide 1 exterior right slide 1 inner left slide 1 exterior left slide

Qualities:
- Versability & precision in the mounting
- Automatic closure of the drawer due to the inclination of both sides

Technical Characteristics	
Assembly	Basal
Bearing	Roller
Saline fog camera resistance	400 hours
Colors	Black, white & brown
Dimensions	Lengths: 300 - 600 mm
Hole pattern	32 line drilling system
Components (For 1 drawer)	1 right inner slide 1 left inner slide 1 right exterior slide 1 left exterior slide
Carcase/drawer Gap	12.5 + 0.5 - 0.2 mm

Isiometric view

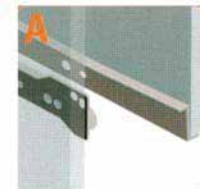
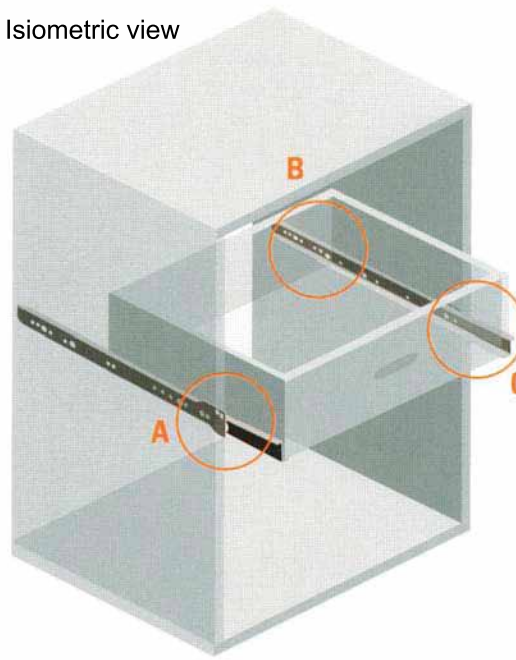

Left slide

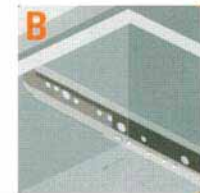

Right slide



Right slide

Schematic plan

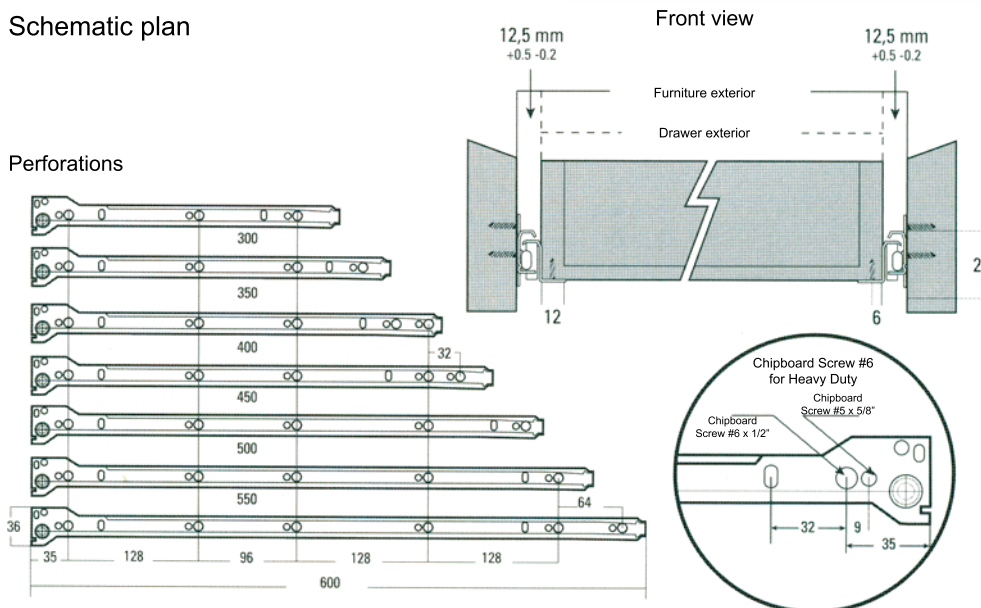

Office Systems

Full extension slide

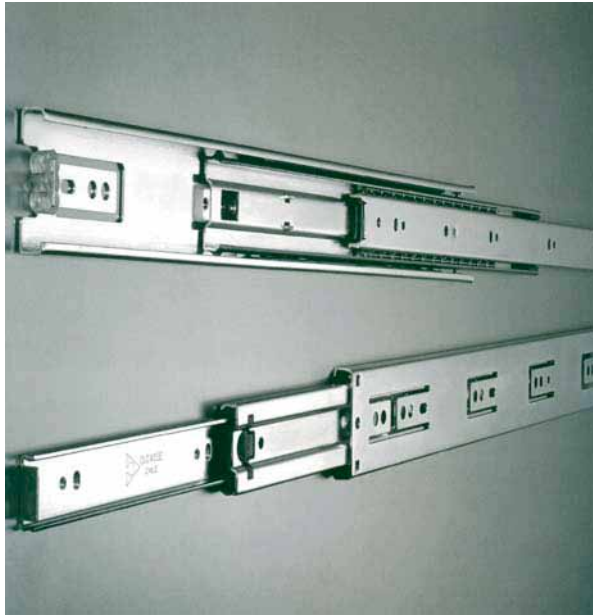

Full extension ball bearing slide, with lateral mounting on the drawer

Uses	Office furniture Hanging folder drawer Extendable tables
Capacity	99 lbs per set
Life utility	Grade 1HD
Components	2 full extension slides

- Qualities:
- Resistance & functionality
 - The drawer can be reached to its full length due to the full extension of the slide
 - Stopper included in the system guarantees an hermetic closure of the drawer

Schematic view

Front view

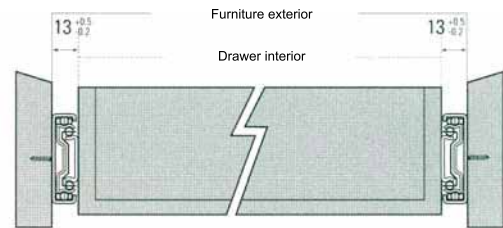

Perforations



Technical Characteristics	
Assembly	Lateral
Bearing	Ball
Saline fog camera resistance	100 hours
Colors	White & black Zinc plated
Dimensions	300 - 600 mm
Components	2 full extension slides
Hole pattern	32 line drilling system
Carcase/Drawer cap	13 + 0.5 - 0.2 mm

Code	L	Route	A	B	C	D	E	F
DE600	300	300	----	----	96	128	----	----
DE6100	350	350	----	----	96	160	----	----
DE800	400	400	96	----	96	96	128	----
DE8100	450	450	128	----	96	96	160	----
DE1000	500	500	128	64	128	192	96	----
DE10100	550	550	128	96	96	96	192	64
DE1200	600	600	128	128	96	96	192	96

Isiometric view

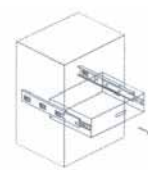
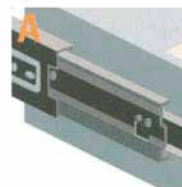
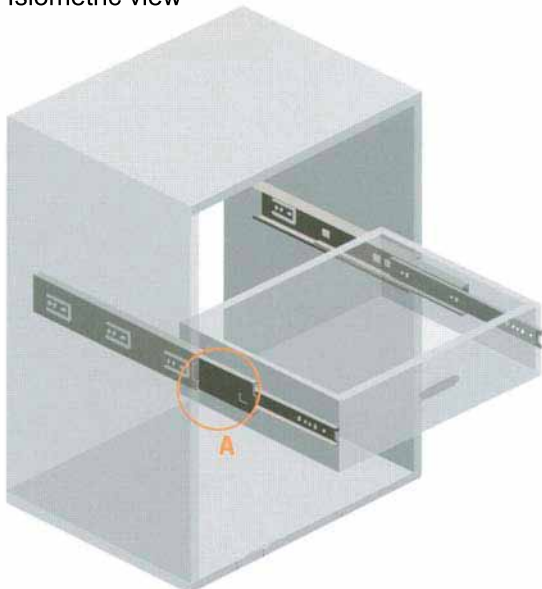

Full extension ball bearing slide, with lateral mounting on the drawer

(*) All measures expressed in (mm)

Sliding System



Kitchen systems
Concealed slide

Partial extension slide with an extra smooth displacement. Includes an automatic closure system that assures an hermetic closing. It has the quality of being hidden underneath the drawer

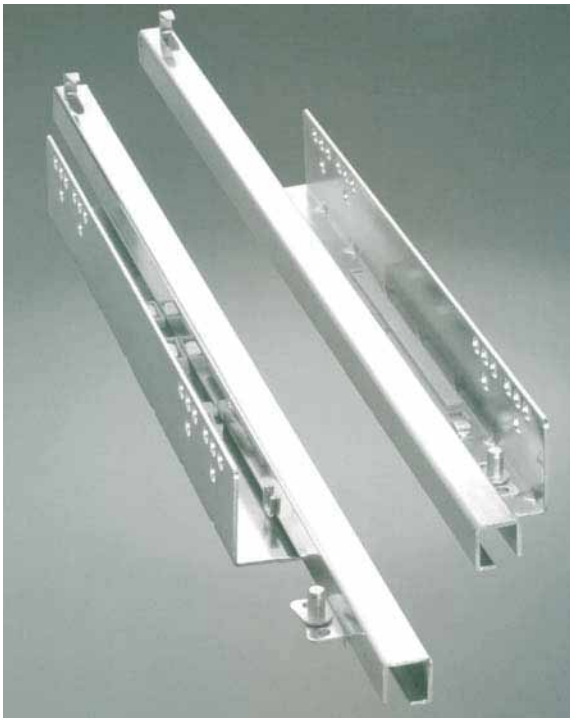

Uses	Office & kitchen furniture
Capacity	22 Kg
Life utility	10 years - 35.000 cycles
Components	1 right slide 1 left slide

- Qualities:
- Great smoothness when operating
 - Automatic closing system incorporated
 - Regulation system to level drawer front
 - Easy mounting & unmounting of the drawer
 - Stays hidden to the view

Technical Characteristics	
Assembly	Basal
Bearing	Roller retainer
Saline fog camera resistance	100 hours
Colors	White zinc plated
Dimensions	Lengths: 10" - 24"
Hole pattern	32 line drilling system
Components (For 1 drawer)	1 right slide 1 left slide
Panel thickness	0.4" - 0.62" (according to drawer sides)
Carcase/drawer Gap	0.16" - 0.3" (according to drawer width)

Schematic plan

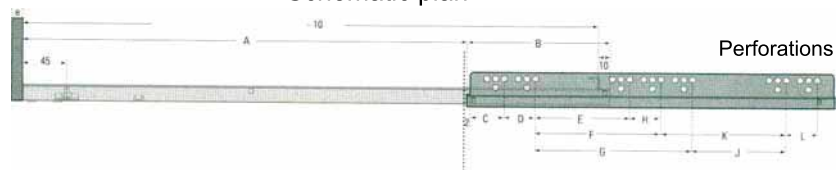

Front view

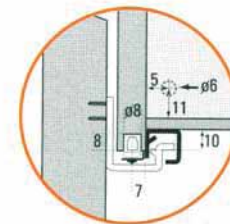
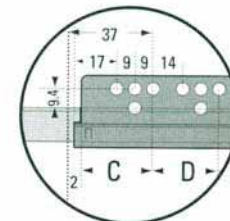
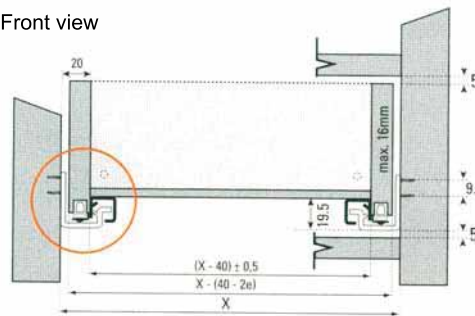

Isiometric view

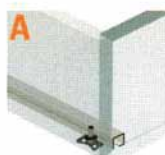
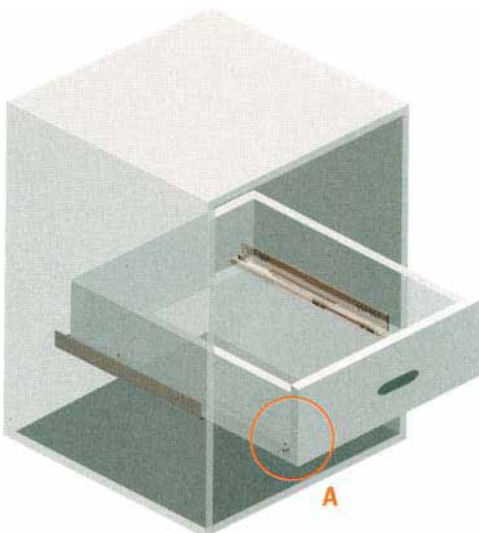

Concealed slide

Code	A	B	C	D	E	F	G	H	J	K	L
DE4100	172	53	35	32	96	128	---	32	---	---	---
DE600	222	53	35	32	96	128	---	32	---	---	---
DE6100	272	53	35	32	---	128	160	32	---	---	---
DE800	322	53	35	32	---	---	160	32	---	---	---
DE8100	337	88	35	32	---	---	160	32	---	---	---
DE1000	487	88	35	32	96	128	---	32	96	128	---
DE10100	407	118	35	32	96	128	---	32	96	128	---
DE1200	457	118	35	32	96	128	160	32	96	128	32

(*) All measures expressed in (mm)

Insert nut



Part.No	Finish	L(mm)
IA610044	Plain	13
IA610044	Plain	17
IA610044	Plain	20

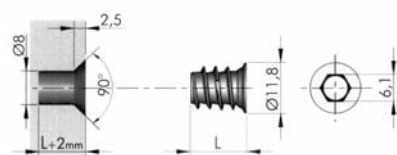

Part.No	L(mm)
IA6102602	8
IA610262	10

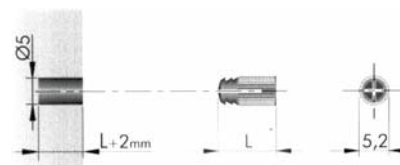

Spreading dowel

Insert nut



Part.No M8	Part.No7/16	Finish	L(mm)
IA610084	IA610082	Plain	15
IA610088	IA610086	Plain	18
IA6100812	IA6100810	Plain	22

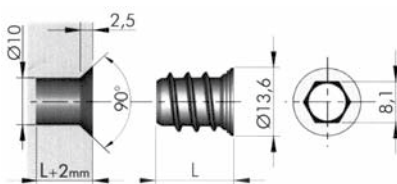

Part.No	L(mm)
IA6102040	7.5
IA6102002	10

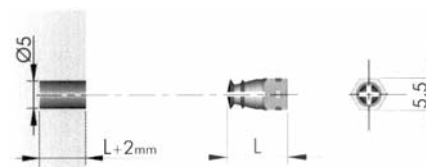

Spreading dowel

Insert nut



Part.No	Finish	L(mm)
IA61002014	Yellow Zinc	10
IA61002016	Yellow Zinc	12
IA61002018	Yellow Zinc	15
IA6100222	Yellow Zinc	18
IA6100224	Yellow Zinc	20
IA6100226	Yellow Zinc	25

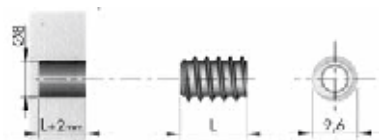

Part.No	L(mm)
IA610244	11

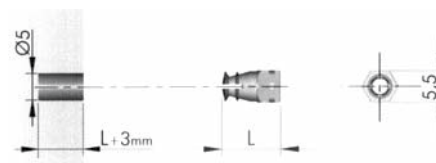

Spreading dowel

Insert nut



Part.No M8	Part.No7/16	Finish	L(mm)
IA6100628	IA6100102	Yellow Zinc	12
IA61006212	IA6100104	Yellow Zinc	15
IA61006216	IA6100106	Yellow Zinc	18
IA6100640	IA6100108	Yellow Zinc	20
IA6100644	IA61001010	Yellow Zinc	25

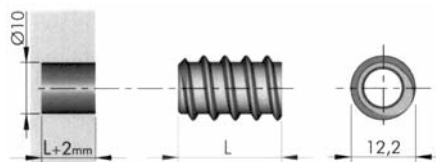

Part.No	L(mm)
IA6102066	12



Spreading dowel

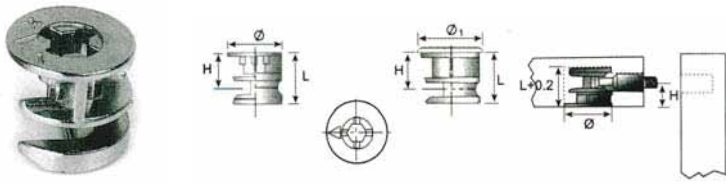

Ø15 Sided connecting cam fittings
Finish:Zn-plated, NI-Plated Mat:Zn-Alloy

Code	∅	L	H	∅ ₁		
RCQZZ02	15	12	7.5	16.5	15	2500
RCQZZ04	15	13.5	9	16.5	18	2500
RCQZZ06	15	12	7.5	15	15/16	2500
RCQZZ08	15	13.5	9	15	18/20	2500

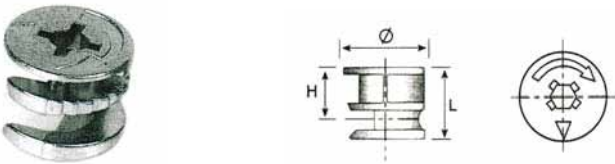

Ø15 Sided connecting cam fittings
Finish:Zn-plated, NI-Plated Mat:Zn-Alloy

Code	∅	L	H		
RCQZZ010	15	12	7.5	15/16	2500
RCQZZ012	15	13.8	9	18/20	2500

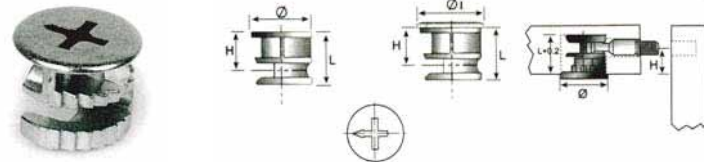

Ø15 Sided connecting cam fittings
Finish:Zn-plated, NI-Plated Mat:Zn-Alloy

Code	∅	L	H	∅ ₁		
RCQZZ014	15	12	7.5	16.5	15	2500
RCQZZ016	15	12	7.5	15	15/16	2500



Ø15 Sided connecting cam fittings
Finish:Zn-plated, NI-Plated Mat:Zn-Alloy

Code	∅	L	H	∅ ₁		
RCQZZ018	15	12	7.5	16.5	15	2500
RCQZZ20	15	12.5	8	16.5	16	2500
RCQZZ22	15	12	7.5	15	15	2500
RCQZZ24	15	12.5	8	15	16	2500

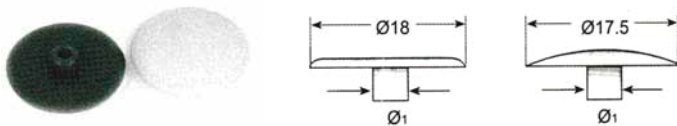

Cover cap
Finish:White, Black, Brown Mat:Plastics

Code	∅	∅ ₁	
RCQOZ02	18	4	10000
RCQOZ04	17.5	4	10000

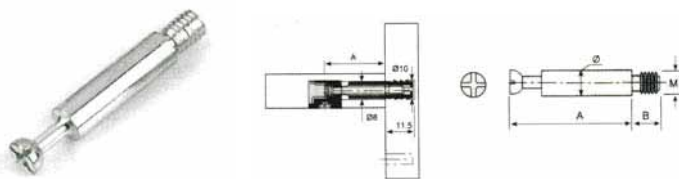

Screw Dowel
Finish:Zn-plated Mat:Iron

Code	∅	A	B	M	
RCQAZ02	6.7	34	8	6	2500
RCQAZ04	6.7	28	8	6	2500
RCQAZ06	6.7	24	8	6	2500



Screw Dowel
Finish:Zn-plated Mat:Iron

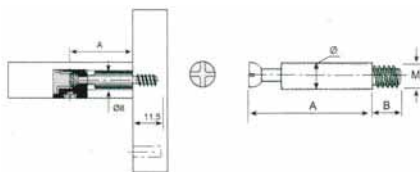

Code	∅	A	B	M	
RCQAZ08	6.7	34	11	6	2500
RCQAZ010	6.7	24	11	6	2500
RCQAZ012	6.7	34	9	6	2500
RCQAZ014	6.7	24	9	6	2500



Screw Dowel
Finish:Zn-plated Mat:Iron

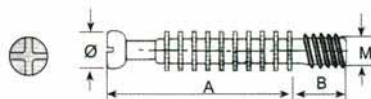

Code	∅	A	B	M	
RCQAZ016	6	34	9	6	1000
RCQAZ018	6	24	9	6	1000



Screw Dowel
Finish:Zn-plated Mat:Iron

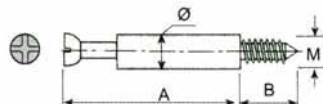

Code	∅	A	B	M	
RCQAZ20	5	24	9	4	5000
RCQAZ22	5	24	12	4	5000
RCQAZ24	6	34	12	4	3000
RCQAZ26	6	24	12	4	5000
RCQAZ28	6.7	34	12	4	4000
RCQAZ210	6.7	24	12	4	5000



Screw Dowel
Finish:Zn-plated Mat:Iron

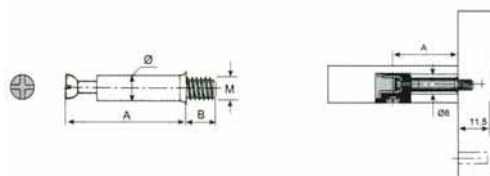

Code	∅	A	B	M	
RCQAZ212	5.8	25	9	6.2	5000
RCQAZ214	5.8	23.5	9	6.2	5000
RCQAZ216	5.8	25	11	6.2	3000
RCQAZ218	5.8	23.5	11	6.2	5000



Screw Dowel
Finish:Zn-plated+black Mat:Zn-Alloy+plastics

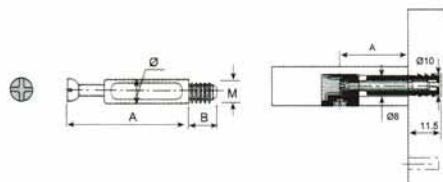

Code	∅	A	B	M	
RCQAZ40	7.5	34	7.5	6	2500
RCQAZ42	7.5	24	7.5	6	2500



Fast Assembly Dowel
Finish:Zn-plated+black Mat:Zn-Alloy+plastics

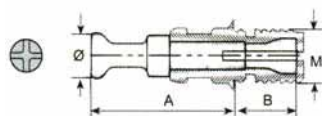

Code	∅	A	B	M	
RCQAZ44	7	34	11	8	5000
RCQAZ46	7	24	11	8	5000



Double Dowel
Finish:Zn-plated Mat:Iron

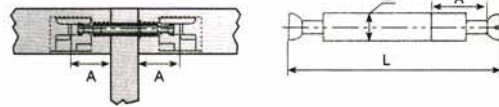

Code	ϕ	A	L	
RCQAZ48	6.7	24	64	2000
RCQAZ410	6.7	24	67	2000
RCQAZ412	6.7	34	84	2000
RCQAZ414	6.7	34	87	2000



L-shaped angle Dowel
Finish:Zn-plated Mat:Iron

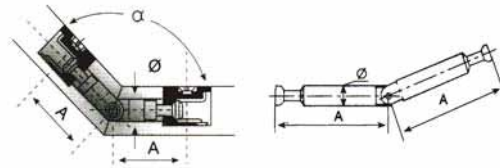

Code	ϕ	A	
RCQAZ416	6.7	44	2000
RCQAZ418	6.7	24	2000



L-shaped angle Dowel(6-7mm)
Finish:Zn-plated Mat:Iron

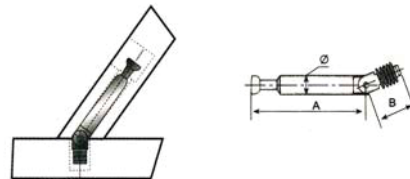

Code	ϕ	A	B	
RCQAZ60	6.5	44	6	2000



T-shaped Connecting Dowel
Finish:Zn-plated Mat:Iron

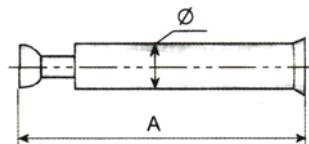

Code	ϕ	A	
RCQAZ26	6.7	40	2500
RCQAZ64	6.7	43	2500



Zn Alloy Connecting Dowel
Finish:Zn-plated Mat:Iron

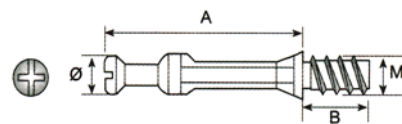

Code	ϕ	A	B	M	
RCQAZ66	7	34	11.5	6	2500
RCQAZ68	7	24	11	6	2500



ϕ 15 sided connecting cam fitting
Finish:Zn-plated, Ni-plated Mat:Zn-Alloy

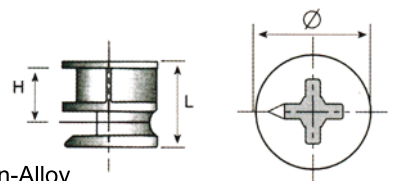

Code	ϕ	A	B	M	
RCQZZ26	15	12	7.5	15/16	5000
RCQZZ28	15	13.5	9	18/20	5000

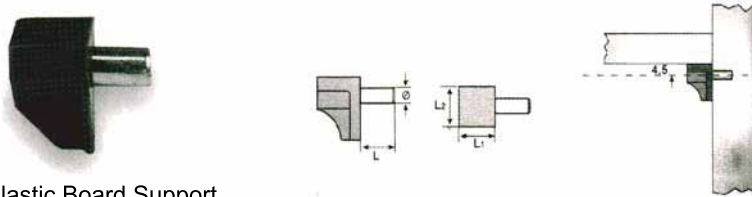

Plastic Board Support
Finish: Zn-plated+Transparent/Brown/White
Mat: Iron+Plastics

Code	∅	L	L ₁	L ₂	
RCQDZ40	5	7	7	9	10000
RCQDZ42	5	8	10	11	5000

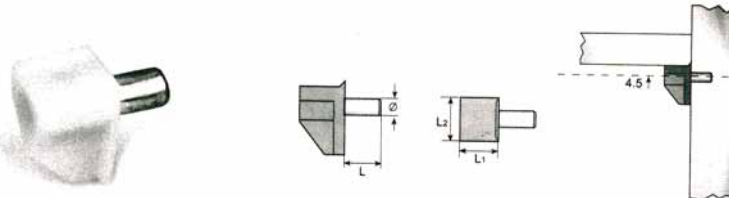

Plastic Board Support
Finish: Zn-plated+Transparent/Brown/White
Mat: Iron+Plastics

Code	∅	L	L ₁	L ₂	
RCQDZ44	5	8	10	11	5000

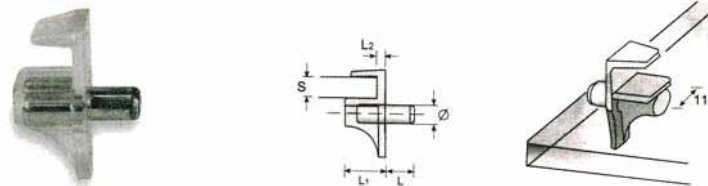

Plastic Board Support
Finish: Zn-plated+Transparent/Brown/White
Mat: Iron+Plastics

Code	∅	L	L ₁	L ₂	S	
RCQDZ46	5	8	10	2	5.5	5000

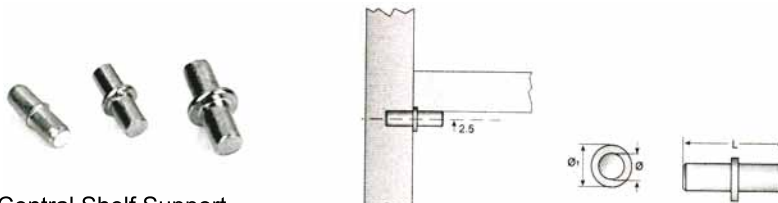

Central Shelf Support
Finish: Zn-plated+Transparent/White
Mat: Iron+Plastics

Code	∅	∅ ₁	L	
RCQDZ48	5	6	16	5000
RCQDZ410	5	8	16	5000
RCQDZ412	6	11	20	5000

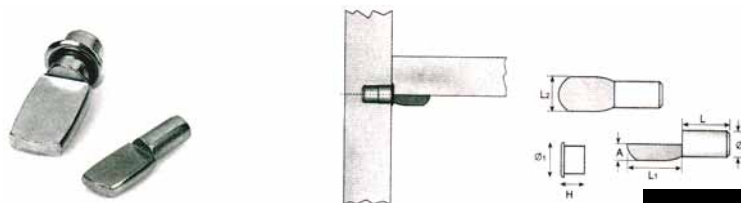

Metal Shelf Support
Finish: Ni-plated
Mat: Iron

Code	∅	∅ ₁	L	L ₁	L ₂	A	H	
RCQDZ414	5	10	9	11	7	3	4	5000
RCQDZ416	7	11	9	15	11	4	6	5000

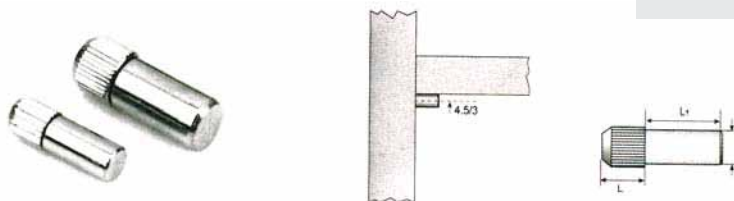

Metal Shelf Support
Finish: Ni-plated
Mat: Iron

Code	∅	L	L ₁	
RCQDZ418	6	7	12	5000
RCQDZ60	9	8	16	2500



Meral Shelf Support
Finish:Ni-plated

Mat:Iron+Plastics ring

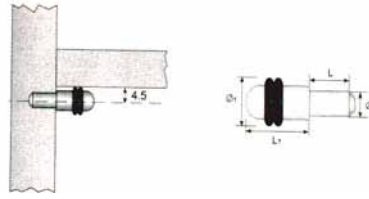

Code	∅	∅ ₁	L	L ₁	
RCQDZ62	3	10	9	11	5000
RCQDZ64	5	10	9	11	5000



Meral Shelf Support
Finish:Ni-plated

Mat:Iron+Plastics ring

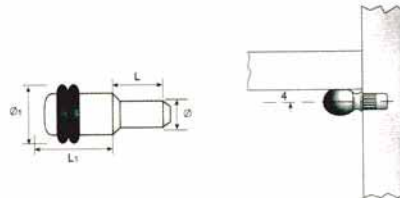

Code	∅	∅ ₁	L	L ₁	
RCQDZ66	5	7.5	9	9	5000



Alloy Board Support
Finish:Ni-plated

Mat:Iron+Plastics

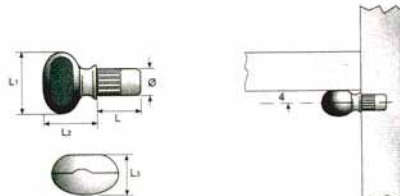

Code	∅	L	L ₁	L ₂	L ₃	
RCQDZ68	5	7.5	14	7.5	8.5	5000



Meral Shelf Support
Finish:Brown, White

Mat:Iron+Plastics

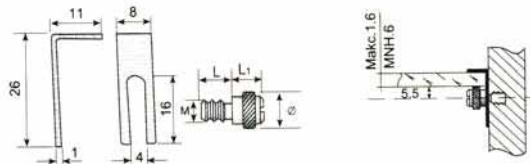

Code	∅	L	L ₁	M	
RCQDZ610	8	9	11	6	5000



Plastic Board Support
Finish:Brown, White

Mat:Iron+Plastics

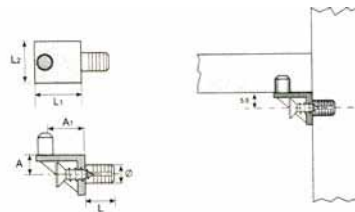

Code	∅	L	L ₁	L ₂	A	A ₁	
RCQDZ612	5	7.5	12	11.5	5.5	9.5	5000



Plastic Board Support
Finish:Brown, White

Mat:Plastics

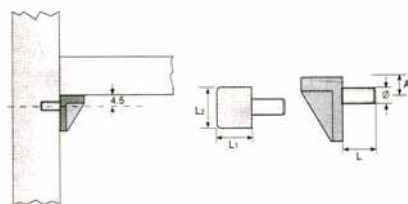

Code	∅	L	L ₁	L ₂	A	
RCQDZ614	5	7.5	9	11	4.5	10000

RCQEB2414

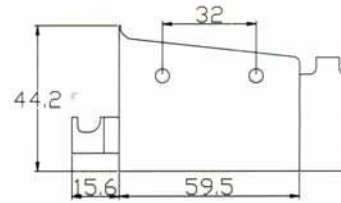

RCQEB2416

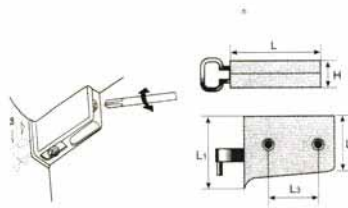
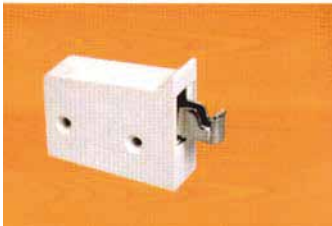

L	L ₁	L ₂	L ₃	H	☑
59	49.5	37	32	18.5	400

Cabinet Suspension Bracket
 Finish:Ni-plated+White/Brown
 Mat:Iron+Plastics

RCQEB2418

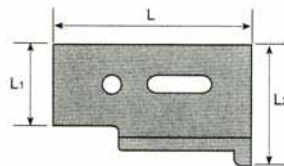
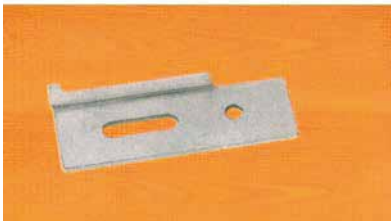

L	L ₁	L ₂	☑
71	22	35	1000

Supporting Plate
 Finish:Ni-plated Mat:Iron

RCQEB260

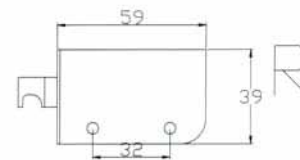
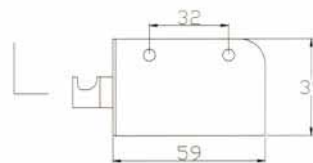
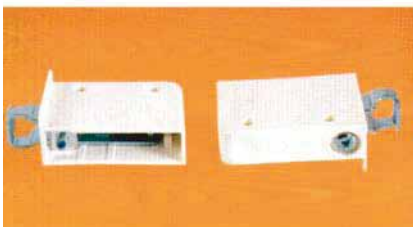

RCQEB262

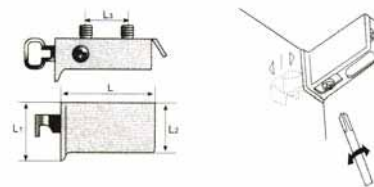

L	L ₁	L ₂	L ₃	H	☑
63	35	31	32	14	400

Cabinet Suspension Bracket
 Finish:Ni-plated+White/Brown
 Mat:Plastics+Iron

RCQEB264

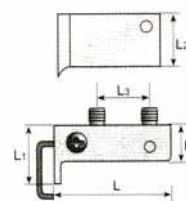

L	L ₁	L ₂	L ₃	H	☑
50	30	29	32	15	400

Cabinet Suspension Bracket
 Finish:Ni-Plated+White/Brown
 Mat:Plastics+Iron

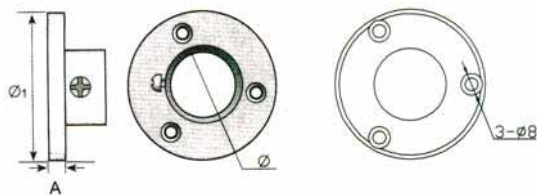

Flange					
Finish	Cr-Plated				
Mat	Zn-Alloy				
Code	Ø	Ø1	A		
RCQGZ212	20	40	3.5	500	

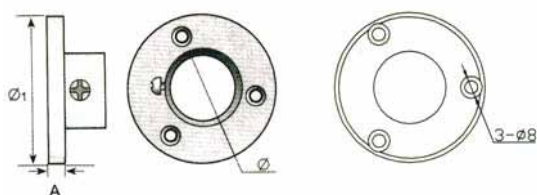

Flange					
Finish	Cr-Plated				
Mat	Zn-Alloy				
Code	Ø	Ø1	A		
RCQGZ214	16.5	38	3.5	500	

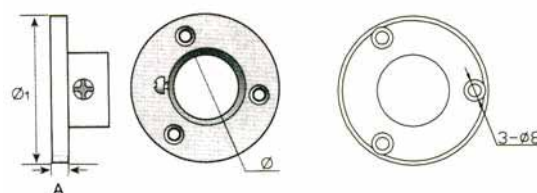

Flange					
Finish	Cr-Plated				
Mat	Zn-Alloy				
Code	Ø	Ø1	A		
RCQGZ216	13.5	35	3	500	

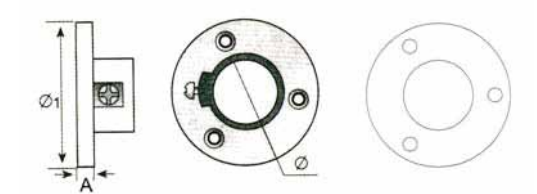

Flange					
Finish	Cr-Plated				
Mat	Zn-Alloy				
Code	Ø	Ø1	A		
RCQGZ218	25.5	51.5	2	400	

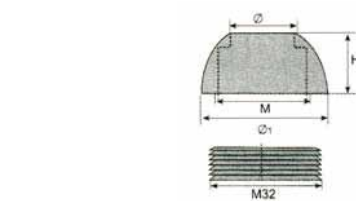

Flange					
Finish	Cr-Plated				
Mat	Zn-Alloy				
Code	Ø	Ø1	Ø2	A	
RCQGZ40	15.5	40	19.5	32	400

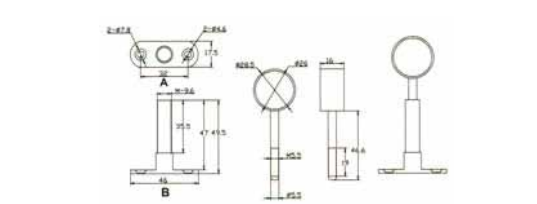

Flange					
Finish	Cr-Plated				
Mat	Zn-Alloy				
Code	Ø	Ø1	Ø2	A	
RCQGZ206	26	28.5	32	46	200

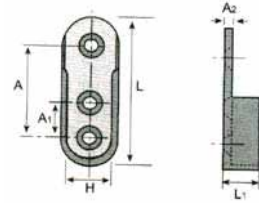

Hanging rail tube support							
Finish	Ni-Plated						
Mat	Zn-Alloy						
Code	H	L	A	A1	A2	L1	
RCQGZ02	15.5	44	32	10	3.5	12.5	1000

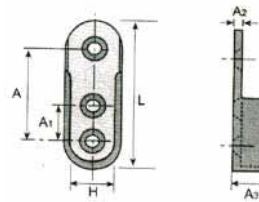

Hanging rail tube support							
Finish	Ni-Plated						
Mat	Zn-Alloy						
Code	H	L	A	A1	A2	A3	
RCQGZ04	15.2	44	32	10	3	12.5	1000

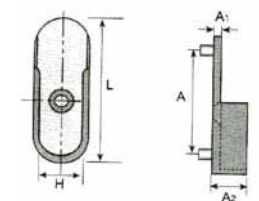

Hanging rail tube support							
Finish	Ni-Plated						
Mat	Zn-Alloy						
Code	H	L	A	A1	A2		
RCQGZ06	15.2	44	32	10	3	1000	

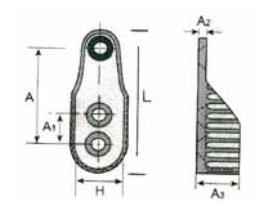

Hanging rail tube support							
Finish	Ni-Plated						
Mat	Zn-Alloy						
Code	H	L	A	A1	A2	A3	
RCQGZ08	15.2	43	32	10	3	12.5	1000

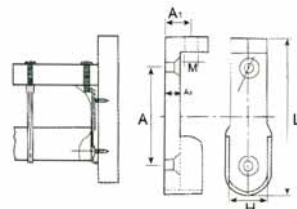

Hanging rail tube support							
Finish	Ni-Plated						
Mat	Zn-Alloy						
Code	H	L	A	A1	A2	M	
RCQGZ10	15.2	64	42	11	6	6	1000

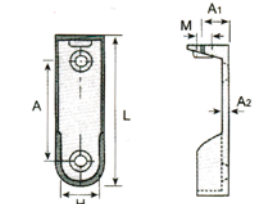

Hanging rail tube support							
Finish	Ni-Plated						
Mat	Zn-Alloy						
Code	H	L	A	A1	A2	M	
RCQGZ12	15.2	64	40	9	4	6	1000

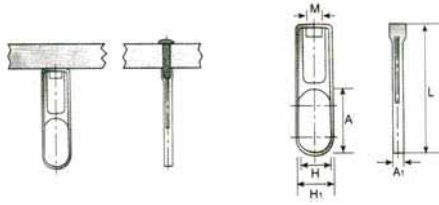

Hanging rail tube support							
Finish	Ni-Plated						
Mat	Zn-Alloy						
Code	H	H1	L	A	A1	M	
RCQGZ014	15.5	18.4	63	30.5	5	6	1000

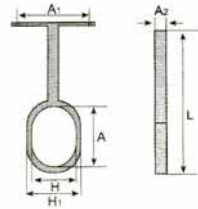

Hanging rail tube support							
Finish	Ni-Plated						
Mat	Zn-Alloy						
Code	H	H1	L	A	A1	M	
RCQGZ016	15.2	20	71	30.5	29	4	1000

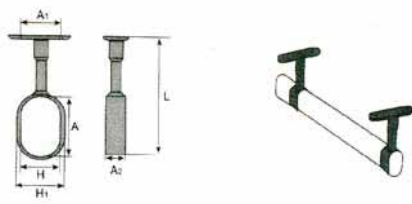

Hanging rail tube support							
Finish	Ni-Plated						
Mat	Zn-Alloy						
Code	H	H1	L	A	A1	A3	
RCQGZ018	16.2	19.5	70	31	34	13	1000

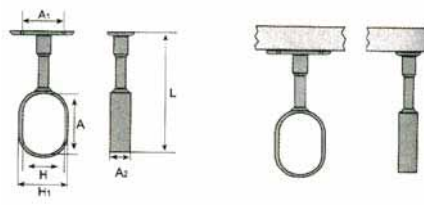

Hanging rail tube support							
Finish	Ni-Plated						
Mat	Zn-Alloy						
Code	H	H1	L	A	A1	A3	
RCQGZ20	16.5	19.5	70	31	34	13	1000

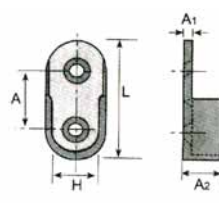

Hanging rail tube support							
Finish	Ni-Plated						
Mat	Zn-Alloy						
Code	H	L	A	A1	A2		
RCQGZ22	19	43	24.5	2	12	1000	

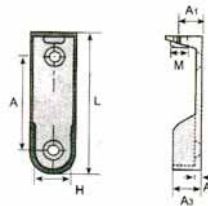

Hanging rail tube support								
Finish	Ni-Plated							
Mat	Zn-Alloy							
Code	H	L	A	A1	A2	A3	M	
RCQGZ24	16.5	19.5	70	31	34	13	34	13

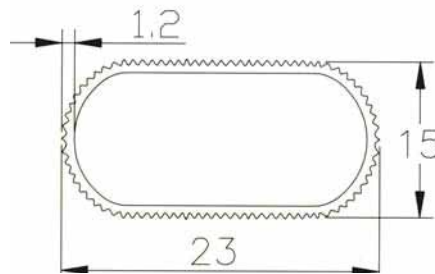

Code	RCQSG0018
Material	Aluminium
Color	Anodized

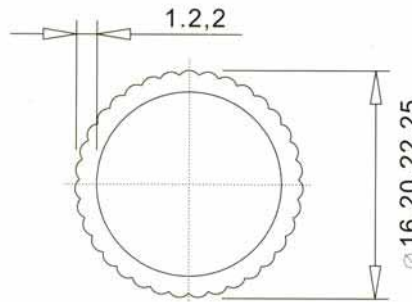

Code	RCQSG0010
Material	Aluminium
Color	Anodized

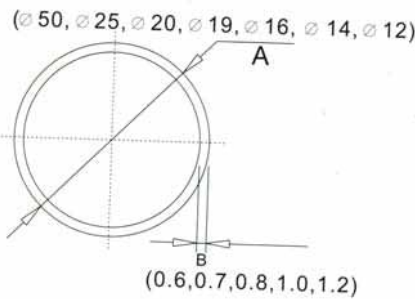

Code	RCQSG0014
Material	Steel
Color	Chrome

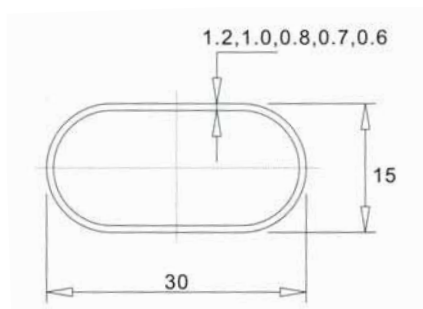

Code	RCQSG0012
Material	Steel
Color	Chrome

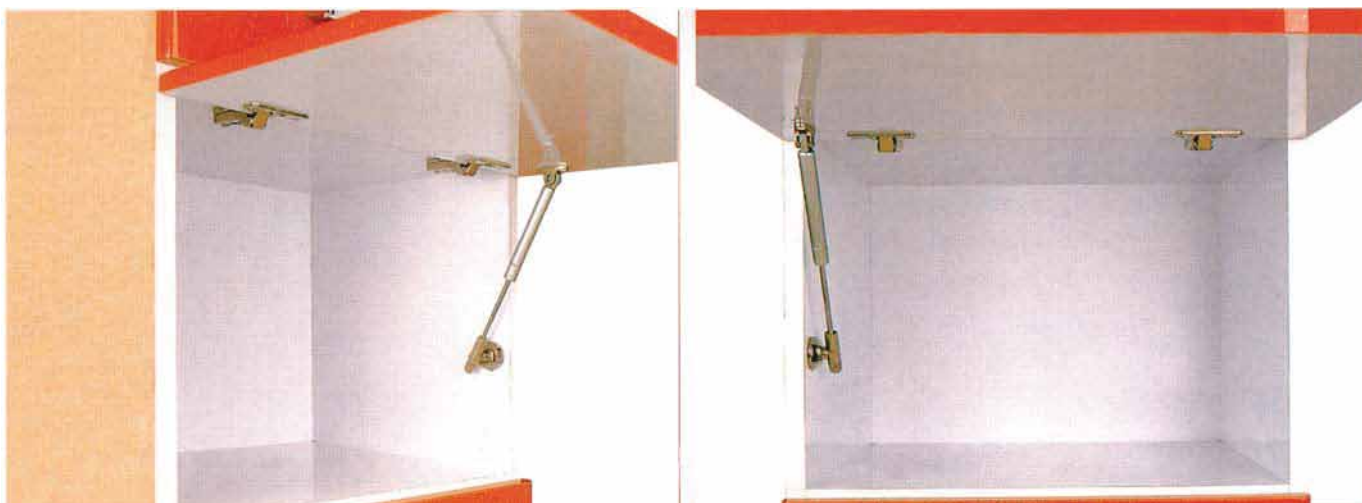

RCQD08E

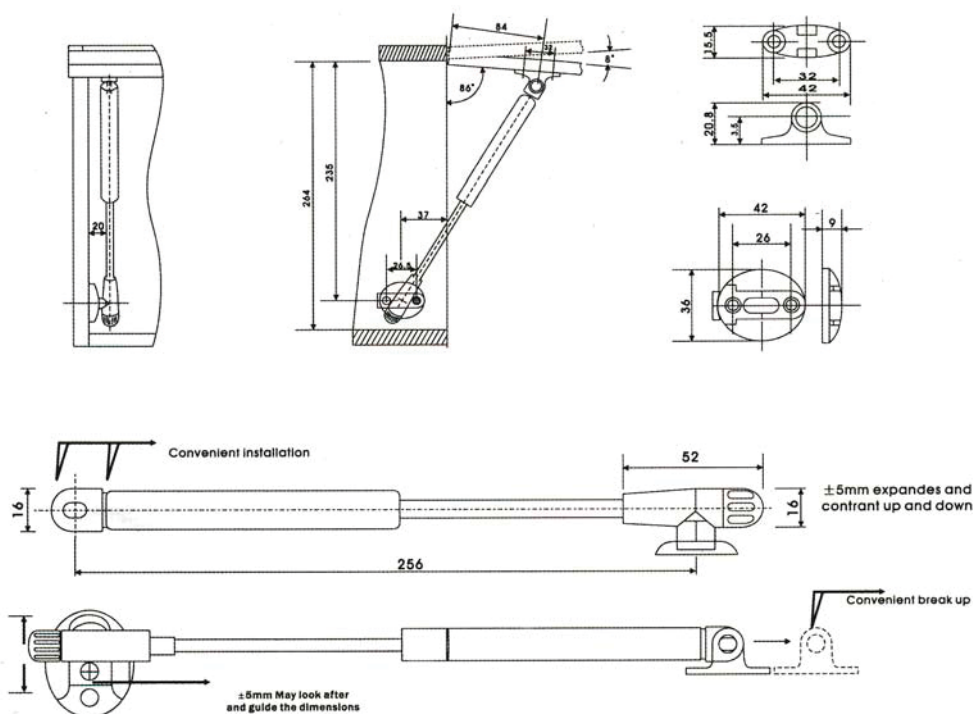

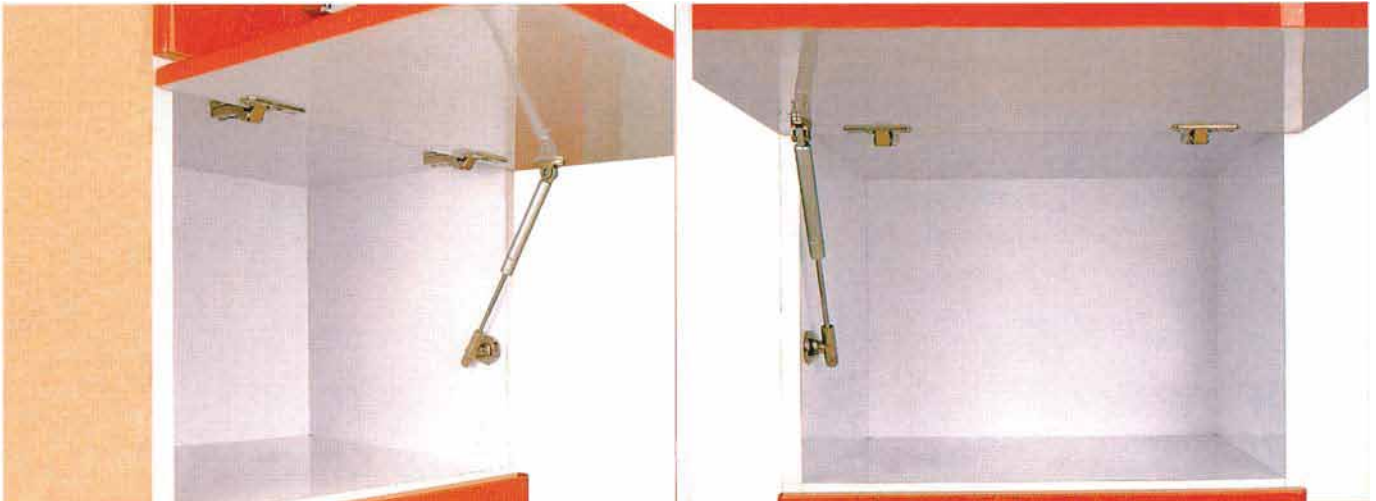

RCQD08F

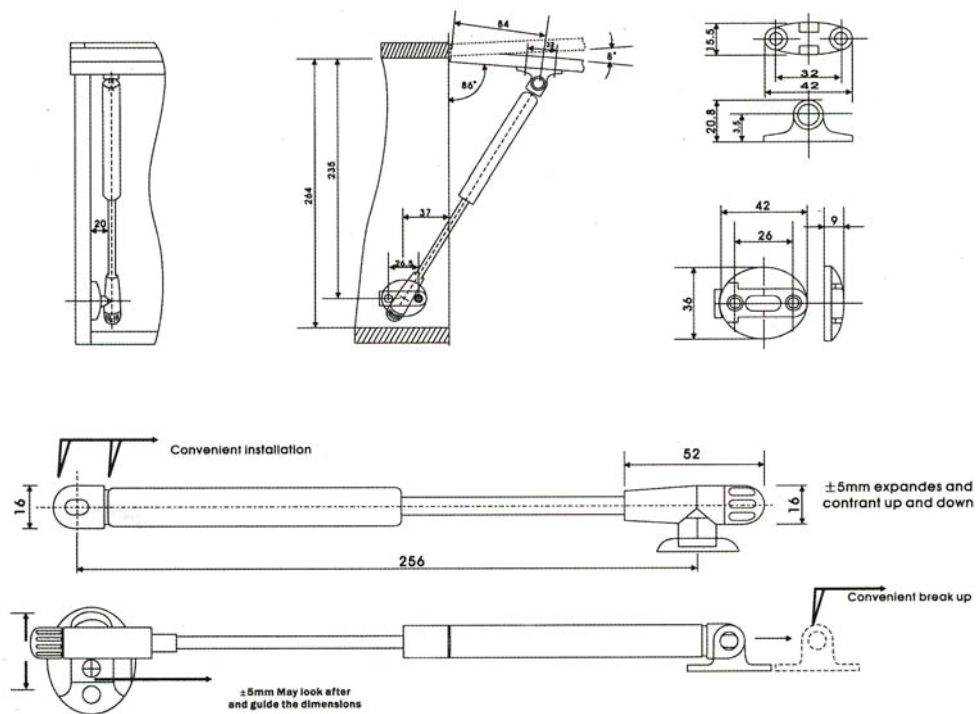

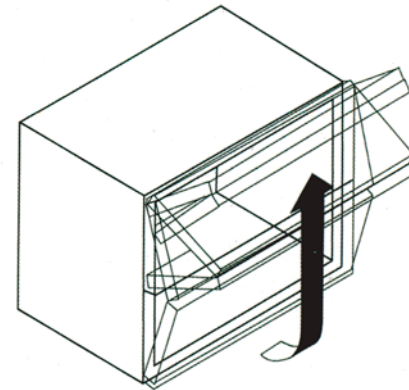
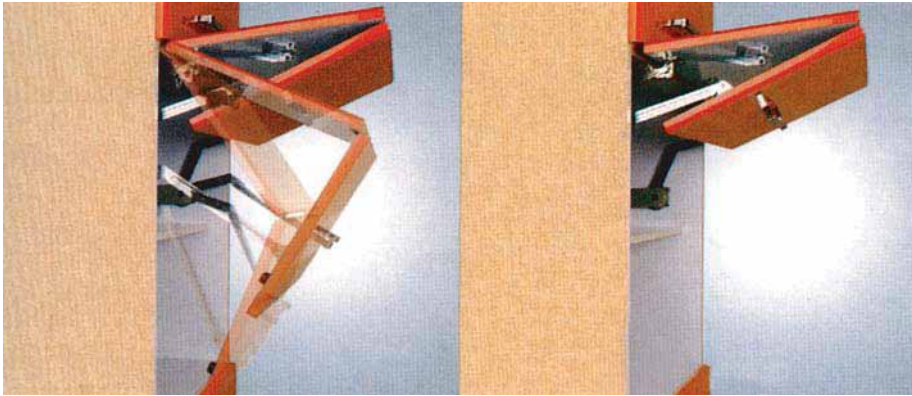

RCQD012F

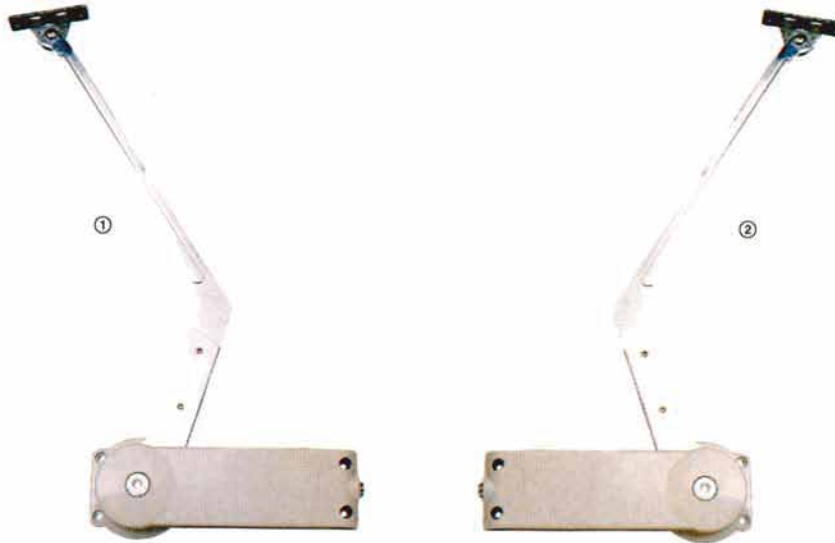

- ① HBF-L left-hand side body 1
- ② HBF-R right-hand side body 1
- ③ Screws 18
- ④ Rubber Bumpers 2

- Hex L-Key 1



5 mm Hex L-Key
(optional parts)

Door Height	A	B	C	D
340	160	232.R	225	50
350	104	242.R	230	45
360	91	253.R	235	35

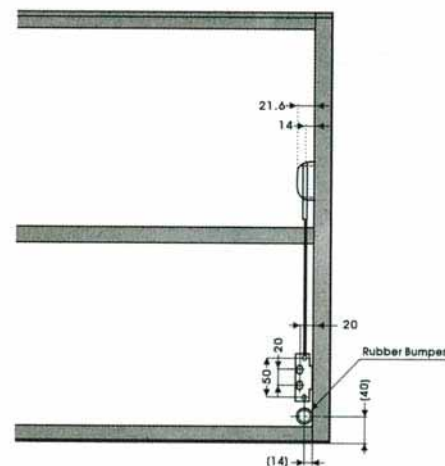
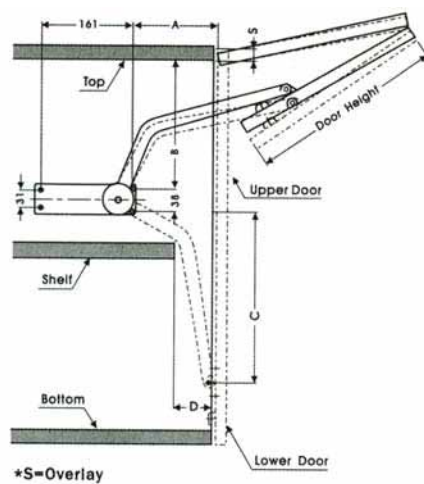

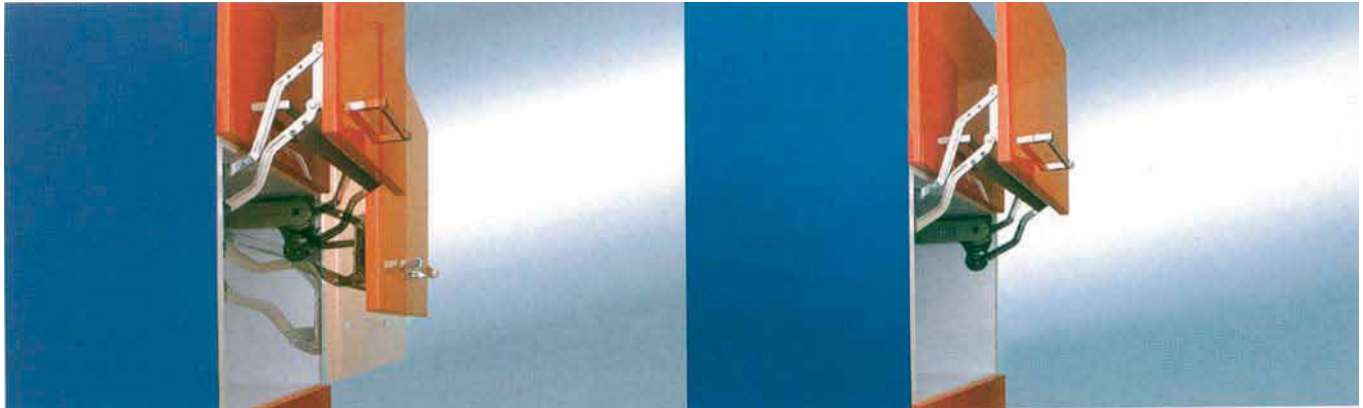

RCQD0126

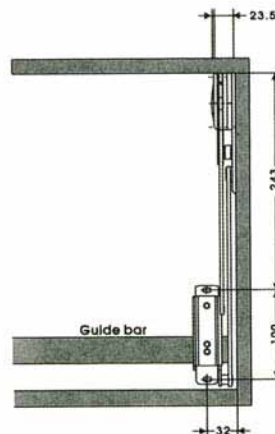
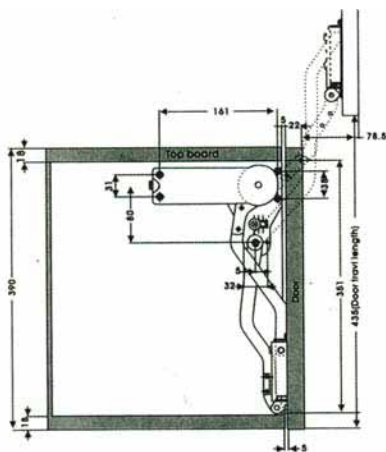
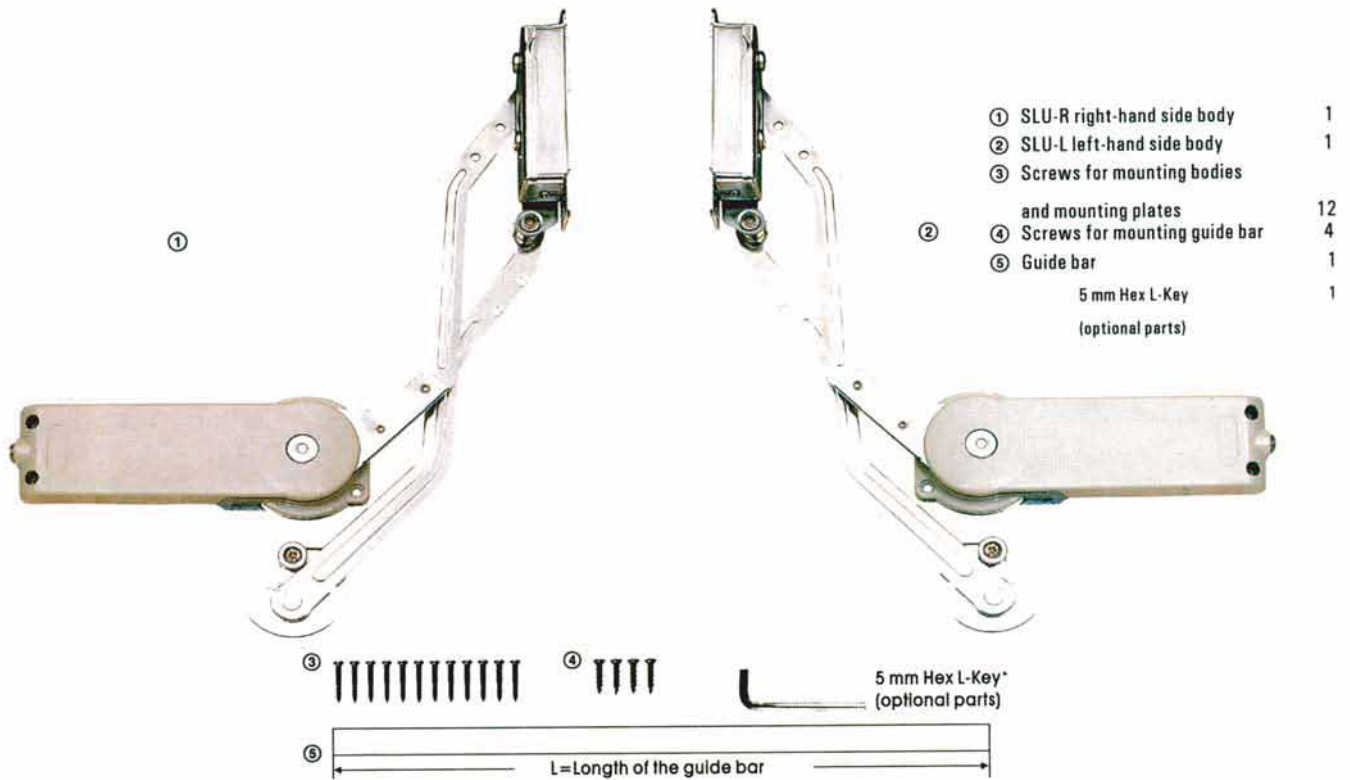

	Cabinet width -600mm(24")	Cabinet width -900mm(36")
Solid wood Door(A)	535mm	835mm
Frame Door(B)	551mm	851mm

When ordering specify the length you require

Aluminium profile for framed shutters



Finishing
Satin anodizing
Polished anodizing
Painting with epoxy dust
Coating in melaminic papers & wood shears

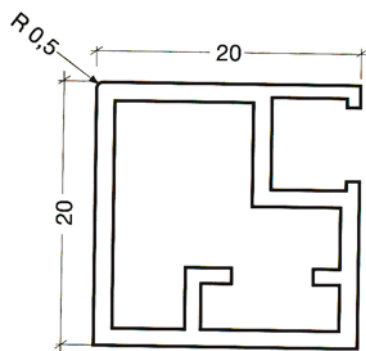

Profile
Code AT21818018141480

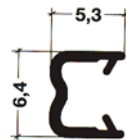

Coextruded gasket
Code AT218180181412810

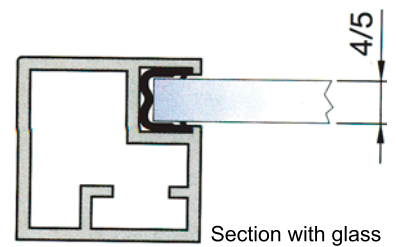
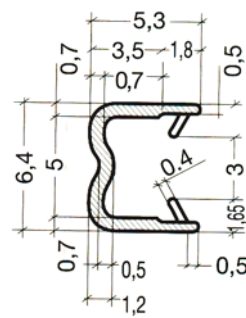

Section with glass



Screw
Code AT412102124204



Bracket
Code AT61002164204

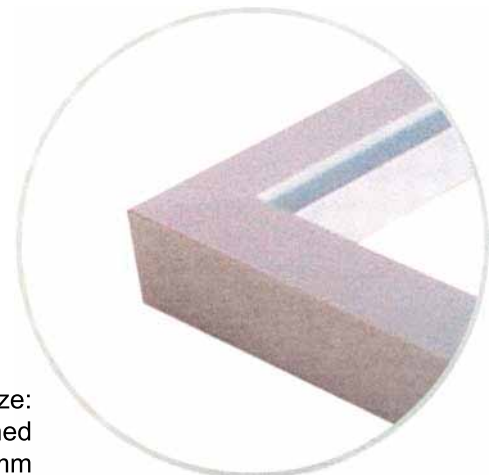

How to determine glass size:
length and width of finished
shutter minus 30mm

Aluminium profile for framed shutters

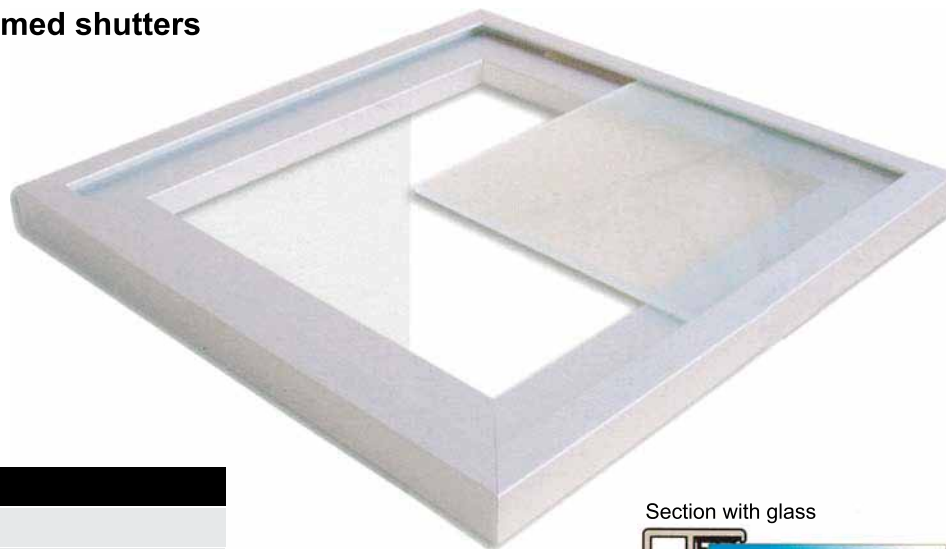

Finishing
Satin anodizing
Polished anodizing
Painting with epoxy dust
Coating in melaminic papers & wood shears

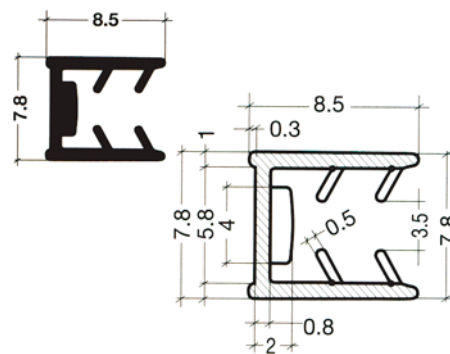
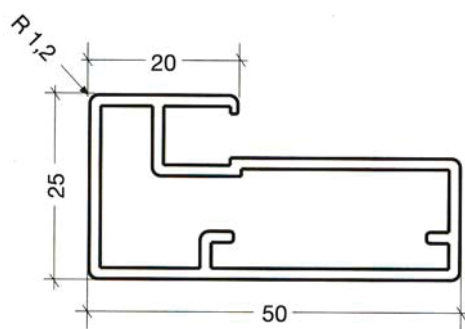
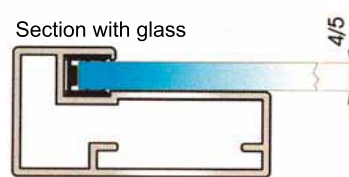

Profile
Code AT2181801812880

Coextruded gasket
Code AT21818018104810



Screw
Code AT412102124204



Bracket
Code AT6104012204

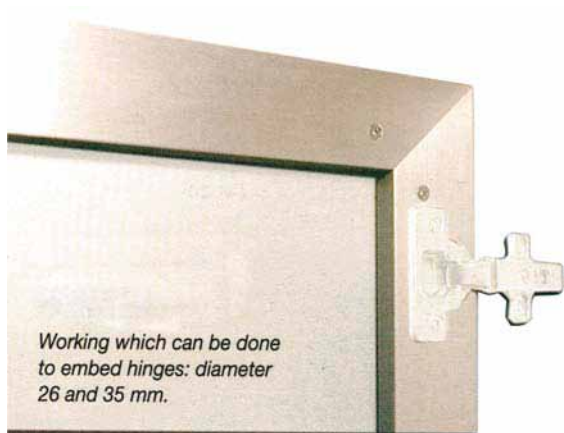

How to determine glass size: length and width of finished shutter minus 27mm

Aluminium profile for framed shutters

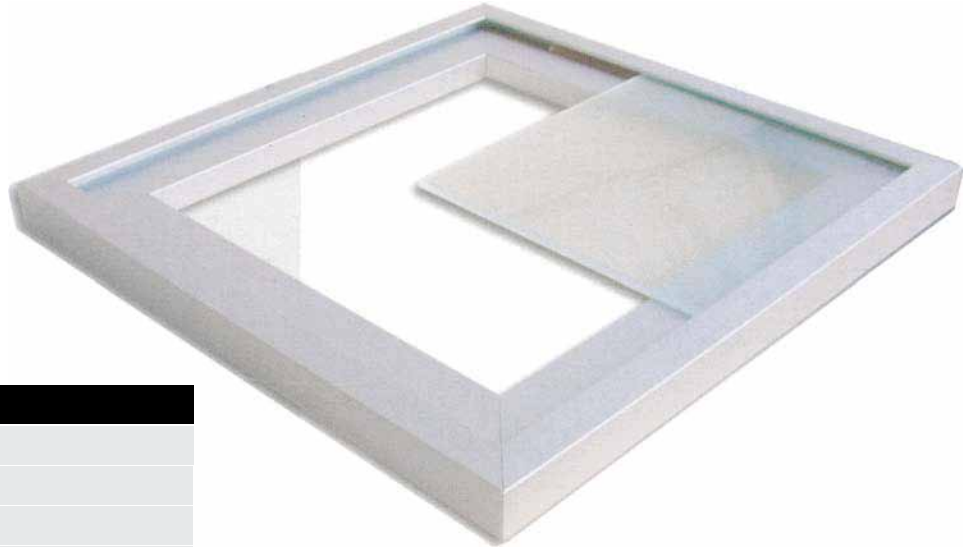

Finishing	
Satin anodizing	
Polished anodizing	
Painting with epoxy dust	
Coating in melaminic papers & wood shears	

How to determine glass size:
length and width of finished
shutter minus 6 mm

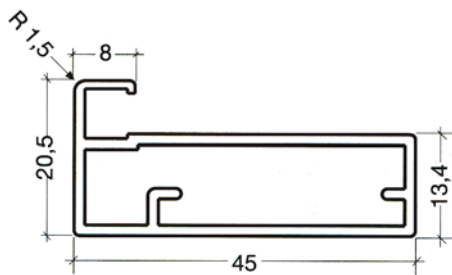
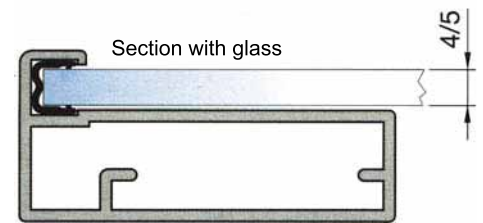

Profile	
Code	AT2181801816880

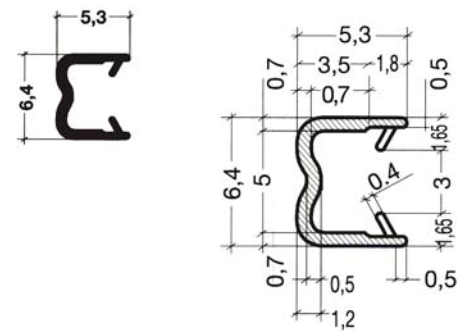

Coextruded gasket	
Code	AT218180181412810



Screw	
Code	AT412102124204



Bracket	
Code	AT61004012204

Aluminium profile for border of wooden shutters

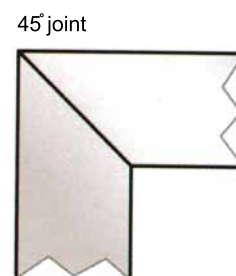
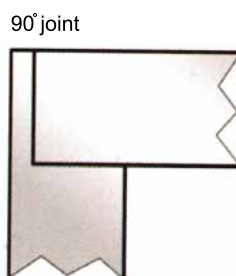
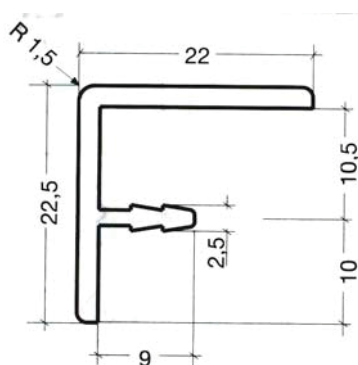
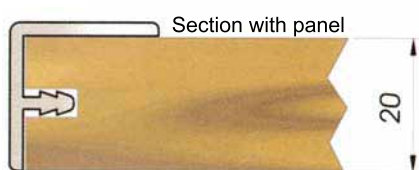

Profile
Code AT2181801812280

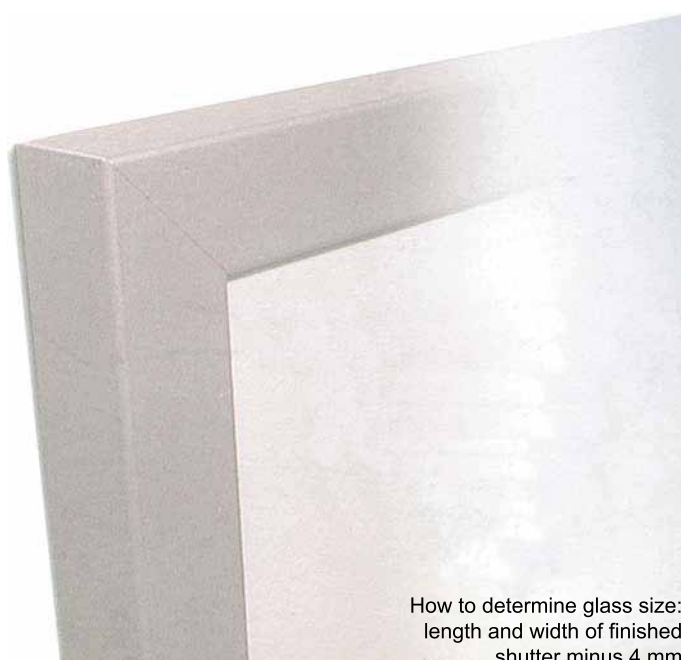

How to determine glass size:
length and width of finished shutter minus 4 mm

Finishing
Satin anodizing
Polished anodizing
Painting with epoxy dust
Coating in melaminic papers & wood shears

Aluminium profile for framed shutters

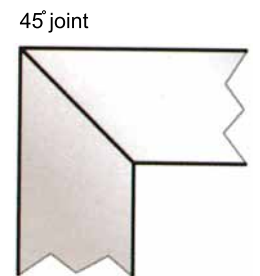
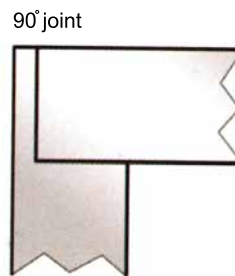
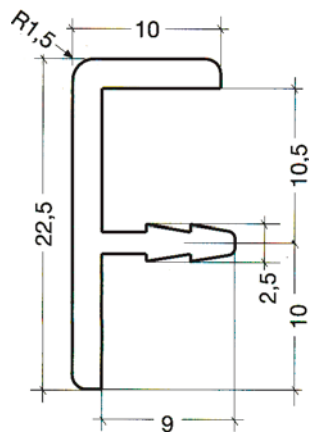
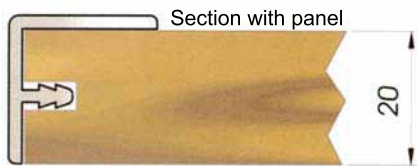

Profile	
Code	AT21818018121080

Finishing	
	Satin anodizing
	Polished anodizing
	Painting with epoxy dust
	Coating in melaminic papers & wood shears



How to determine glass size:
length and width of finished
shutter minus 4 mm

Aluminium profile for framed shutters

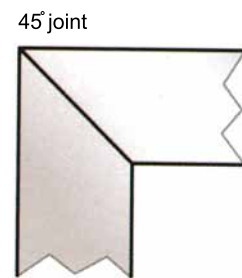
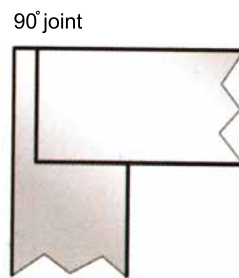
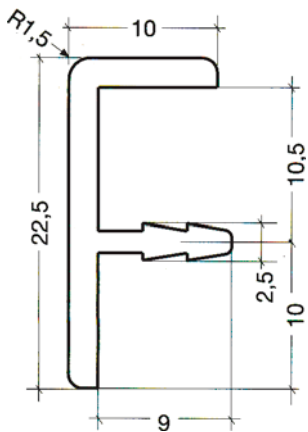
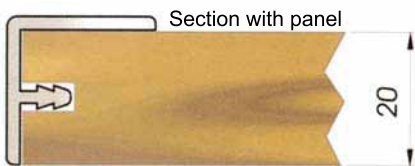

Profile

Code AT21818018121080

Finishing

- Satin anodizing
- Polished anodizing
- Painting with epoxy dust
- Coating in melaminic papers & wood shears



How to determine glass size:
length and width of finished
shutter minus 4 mm

Aluminium handle

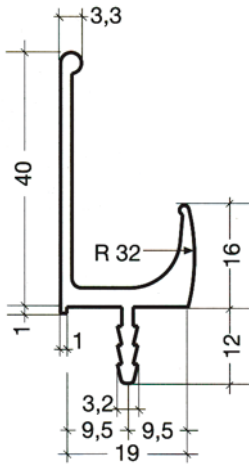

Profile	
Code	AT2181801812680

Finishing	
	Satin anodizing
	Polished anodizing
	Painting with epoxy dust
	Coating in melaminic papers & wood shears

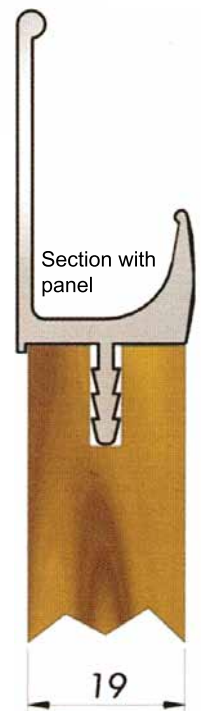

Particular use of fixture as handle



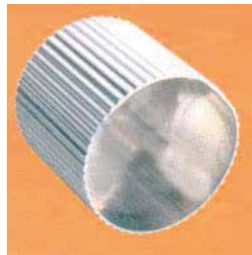
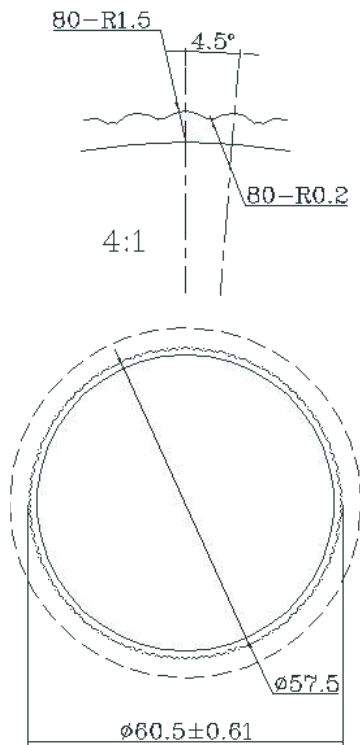

Profile
Code AL4101410



Profile
Code AL4101410

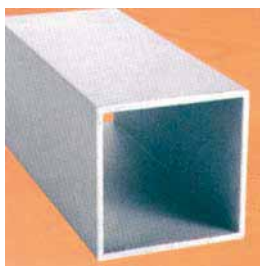
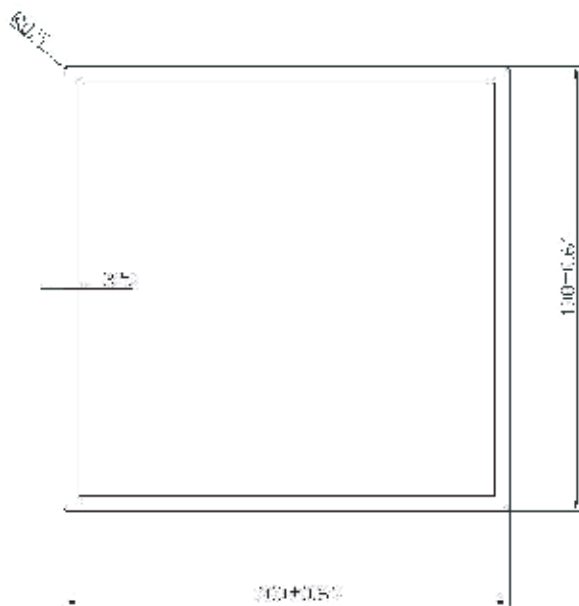

Profile
Code AL82418Z

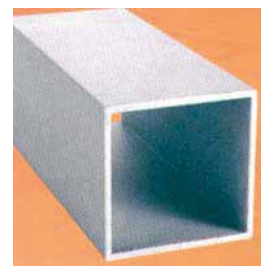
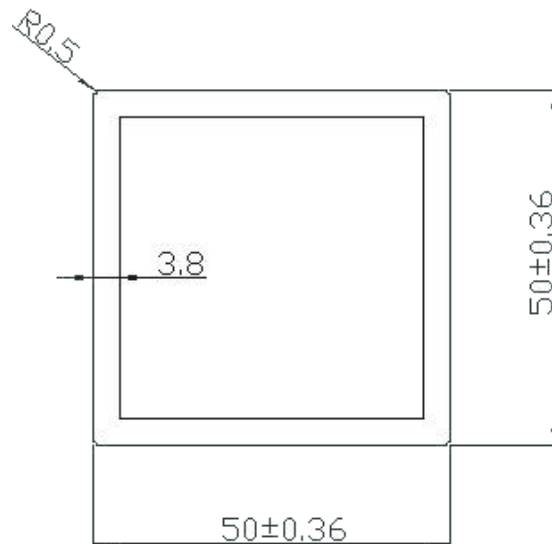

Profile
Code AL8224E

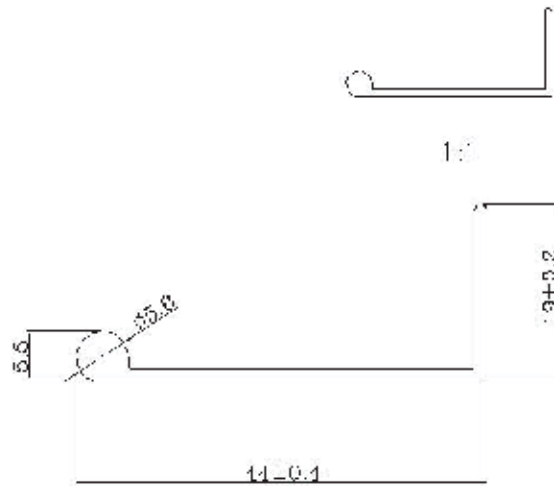

1:1



Profile	
Code	AL4821016

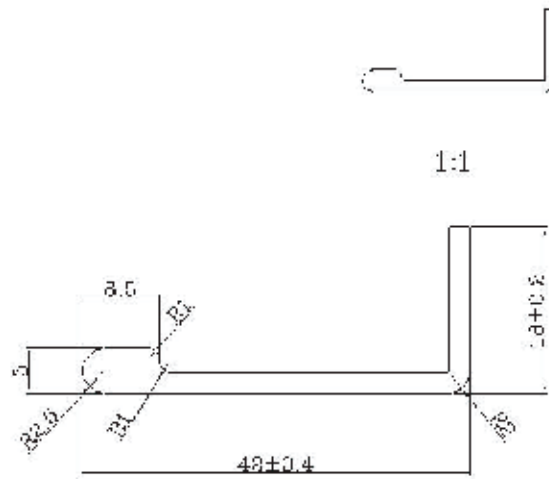

1:1

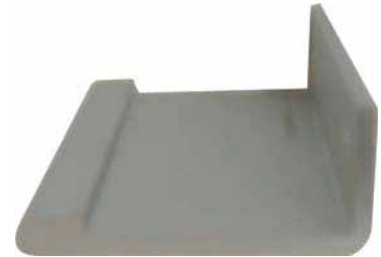

Profile	
Code	AL4821014

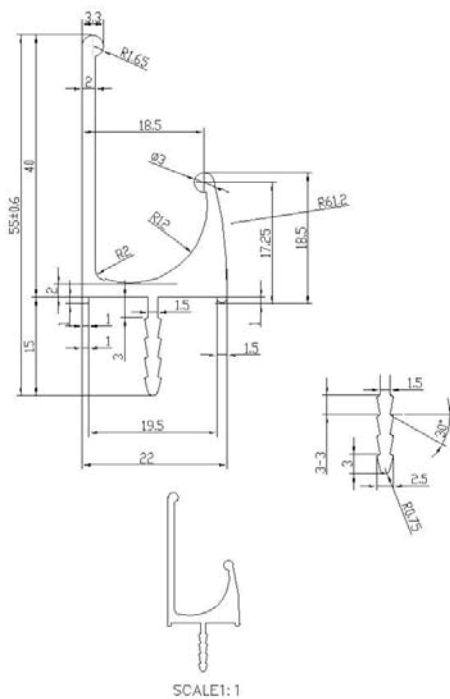

SCALE:1:1

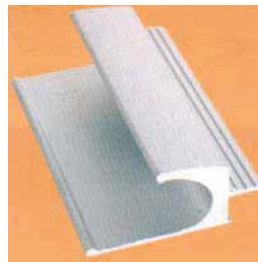

Profile	
Code	ALJ42162

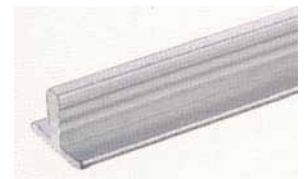
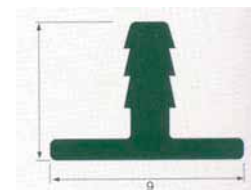

Profile	
Code	ALE60614

